



RX-V620RDS

Natural Sound AV Receiver
Ampli-tuner audio-vidéo

OWNER'S MANUAL
MODE D'EMPLOI
BEDIENUNGSANLEITUNG
BRUKSANVISNING
MANUALE DI ISTRUZIONI
MANUAL DE INSTRUCCIONES
GEBRUIKSAANWIJZING

CAUTION: READ THIS BEFORE OPERATING YOUR UNIT.

- 1 To assure the finest performance, please read this manual carefully. Keep it in a safe place for future reference.
- 2 Install this unit in a well ventilated, cool, dry, clean place with at least 30 cm on the top, 20 cm on the right and left, and 10 cm at the back of this unit for ventilation space — away from direct sunlight, heat sources, vibration, dust, moisture, and/or cold.
- 3 Locate this unit away from other electrical appliances, motors, or transformers to avoid humming sounds. To prevent fire or electrical shock, do not place this unit where it may get exposed to rain, water, and/or any type of liquid.
- 4 Do not expose this unit to sudden temperature changes from cold to hot, and do not locate this unit in a environment with high humidity (i.e. a room with a humidifier) to prevent condensation inside this unit, which may cause an electrical shock, fire, damage to this unit, and/or personal injury.
- 5 On the top of this unit, do not place:
 - Other components, as they may cause damage and/or discoloration on the surface of this unit.
 - Burning objects (i.e. candles), as they may cause fire, damage to this unit, and/or personal injury.
 - Containers with liquid in them, as they may cause electrical shock to the user and/or damage to this unit.
- 6 Do not cover this unit with a newspaper, tablecloth, curtain, etc. in order not to obstruct heat radiation. If the temperature inside this unit rises, it may cause fire, damage to this unit, and/or personal injury.
- 7 Do not plug in this unit to a wall outlet until all connections are complete.
- 8 Do not operate this unit upside-down. It may overheat, possibly causing damage.
- 9 Do not use force on switches, knobs and/or cords.
- 10 When disconnecting the power cord from the wall outlet, grasp the plug; do not pull the cord.
- 11 Do not clean this unit with chemical solvents; this might damage the finish. Use a clean, dry cloth.
- 12 Only voltage specified on this unit must be used. Using this unit with a higher voltage than specified is dangerous and may cause fire, damage to this unit, and/or personal injury. YAMAHA will not be held responsible for any damage resulting from use of this unit with a voltage other than specified.
- 13 To prevent damage by lightning, disconnect the power cord from the wall outlet during an electrical storm.
- 14 Take care of this unit so that no foreign objects and/or liquid drops inside this unit.
- 15 Do not attempt to modify or fix this unit. Contact qualified YAMAHA service personnel when any service is needed. The cabinet should never be opened for any reasons.
- 16 When not planning to use this unit for long periods of time (i.e. vacation), disconnect the AC power plug from the wall outlet.
- 17 Be sure to read the “TROUBLESHOOTING” section on common operating errors before concluding that this unit is faulty.
- 18 Before moving this unit, press STANDBY/ON to set this unit in the standby mode, and disconnect the AC power plug from the wall outlet.

This unit is not disconnected from the AC power source as long as it is connected to the wall outlet, even if this unit itself is turned off. This state is called the standby mode. In this state, this unit is designed to consume a very small quantity of power.

■ For U.K. customers

If the socket outlets in the home are not suitable for the plug supplied with this appliance, it should be cut off and an appropriate 3 pin plug fitted. For details, refer to the instructions described below.

Note

- The plug severed from the mains lead must be destroyed, as a plug with bared flexible cord is hazardous if engaged in a live socket outlet.

■ Special Instructions for U.K. Model

IMPORTANT

THE WIRES IN MAINS LEAD ARE COLOURED IN ACCORDANCE WITH THE FOLLOWING CODE:

Blue: NEUTRAL

Brown: LIVE

As the colours of the wires in the mains lead of this apparatus may not correspond with the coloured markings identifying the terminals in your plug, proceed as follows:

The wire which is coloured BLUE must be connected to the terminal which is marked with the letter N or coloured BLACK. The wire which is coloured BROWN must be connected to the terminal which is marked with the letter L or coloured RED. Making sure that neither core is connected to the earth terminal of the three pin plug.

CONTENTS

INTRODUCTION

FEATURES	2
GETTING STARTED	3
Checking the Package Contents	3
Installing Batteries in the Remote Control	3
CONTROLS AND FUNCTIONS	4
Front Panel	4
Remote Control	6
Description of the Numeric Buttons	7
Using the Remote Control	8
Front Panel Display	9
Rear Panel	10

PREPARATION

SPEAKER SETUP	11
Speakers to Be Used	11
Speaker Placement	11
CONNECTIONS	12
Before Connecting Components	12
Connecting Audio Components	12
Connecting Video Components	14
Connecting the Speakers	16
Connecting an External Amplifier	18
Connecting an External Decoder	18
IMPEDANCE SELECTOR Switch	19
Connecting the Power Supply Cords	19
ON-SCREEN DISPLAY (OSD)	20
OSD Modes	20
Selecting the OSD Mode	20
SPEAKER MODE SETTINGS	21
Summary of SPEAKER SET Items	
1A through 1E	21
ADJUSTING THE SPEAKER	
OUTPUT LEVELS	22
Before You Begin	22
Using the Test Tone (TEST DOLBY SUR.)	22

BASIC OPERATION

BASIC PLAYBACK	24
Input Modes and Indications	26
Selecting a Sound Field Program	28
Normal Stereo Reproduction	29
TUNING	30
Connecting the Antennas	30
Automatic (or Manual) Tuning	31
Presetting Stations	32
Tuning in to a Preset Station	33
Exchanging Preset Stations	34
RECEIVING RDS STATIONS	35
Description of RDS Data	35
Changing the RDS Mode	35
PTY SEEK Function	36
EON Function	37
BASIC RECORDING	38

ADVANCED OPERATION

SET MENU	39
Adjusting the Items on the SET MENU	39
1 SPEAKER SET (speaker mode settings)	40
2 L/R BALANCE (balance of the left and	
right main speakers)	42
3 HP TONE CTRL (headphone tone control)	43
4 I/O ASSIGNMENT	43
5 INPUT MODE (initial input mode)	43
6 DOLBY D. SET (Dolby Digitalset)	44
7 DTS SET (DTS LFE level)	44
8 SP DELAY TIME	45
9 DISPLAY SET	45
10 MEMORY GUARD	45
ADJUSTING THE LEVEL OF THE EFFECT	
SPEAKERS	46
SLEEP TIMER	47
Setting the Sleep Timer	47
Canceling the Sleep Timer	47
REMOTE CONTROL FEATURES	48
Selector Dial	48
Commonly Used Buttons in Any Position of the	
Selector Dial	49
Controlling the Components Connected	
to This Unit	49
Button Names and Functions in Each Position	50
Setting the Manufacturer Code	53
Returning to the Factory Setting	54

ADDITIONAL INFORMATION

SOUND FIELD PROGRAM	55
Hi-Fi DSP Programs	55
CINEMA DSP Programs	55
SOUND FIELD PROGRAM PARAMETER	
EDITING	58
What is a sound field?	58
Sound Field Program Parameters	58
Changing Parameter Settings	59
Resetting a Parameter to the Factory-set Value	59
Sound Field Parameter Descriptions	60

APPENDIX

TROUBLESHOOTING	63
SPECIFICATIONS	68
GLOSSARY	69
INDEX	71

FEATURES

Built-in 5-Channel Power Amplifier

- ◆ Minimum RMS Output Power (0.06% THD, 20 Hz – 20 kHz)
Main: 90 W + 90 W (8 Ω)
Center: 90 W (8 Ω)
Rear: 90 W + 90 W (8 Ω)

Multi-Mode Digital Sound Field Processing

- ◆ DTS Decoder
- ◆ Dolby Pro Logic Decoder
- ◆ Dolby Digital Decoder
- ◆ Hi-Fi DSP
- ◆ CINEMA DSP: Combination of YAMAHA DSP Technology and Dolby Pro Logic, Dolby Digital or DTS
- ◆ Virtual CINEMA DSP
- ◆ SILENT CINEMA

Sophisticated AM/FM Tuner

- ◆ 40-Station Random Access Preset Tuning
- ◆ Automatic Preset Tuning
- ◆ Preset Station Shifting Capability (Preset Editing)
- ◆ Multi-Functions for RDS Broadcast Reception

Other Features

- ◆ 96-kHz/24-bit D/A Converter
- ◆ “SET MENU” which Provides You with 10 Items for Optimizing This Unit for Your Audio/Video System
- ◆ Test Tone Generator for Easier Speaker Balance Adjustment
- ◆ 6-Channel External Decoder Input for Other Future Formats
- ◆ BASS EXTENSION Button for Reinforcing Bass Response
- ◆ On Screen Display Function Helpful in Controlling This Unit
- ◆ S Video Signal Input/Output Capability
- ◆ Component Video Input/Output Capability
- ◆ Optical and Coaxial Digital Audio Signal Jacks
- ◆ Sleep Timer
- ◆ Remote Control with Preset Manufacturer Codes

-  indicates a tip for your operation.
- Some operations can be performed by using either the buttons on the main unit or on the remote control. In cases when the button names differ between the main unit and the remote control, the button name on the remote control is given in parentheses in this manual.



Manufactured under license from Dolby Laboratories.

“Dolby”, “AC-3”, “Pro Logic” and the double-D symbol are trademarks of Dolby Laboratories.
Confidential Unpublished Works. ©1992-1997 Dolby Laboratories, Inc. All rights reserved.



Manufactured under license from Digital Theater Systems, Inc. US Pat. No. 5,451,942 and other world-wide patents issued and pending. “DTS” and “DTS Digital Surround” are trademarks of Digital Theater Systems, Inc. Copyright 1996 Digital Theater Systems, Inc. All Rights Reserved.

GETTING STARTED

Checking the Package Contents

Check your package to make sure it has the following items.

Remote control

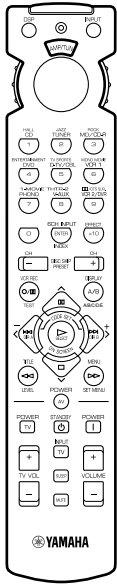

Batteries (4) (AAA, R03, UM-4)

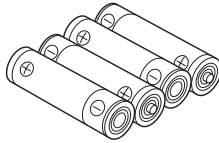

AM loop antenna



Quick Reference Card

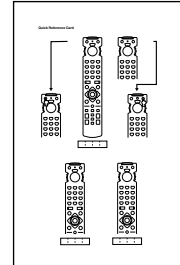

Indoor FM antenna

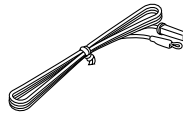

75-ohm/300-ohm antenna adapter (U.K. model only)

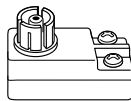

Connection guide

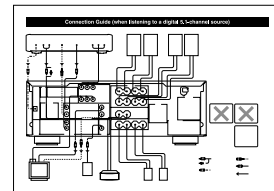

Installing Batteries in the Remote Control

Insert the batteries in the correct direction by aligning the + and – marks on the batteries with the polarity markings (+ and –) inside the battery compartment.

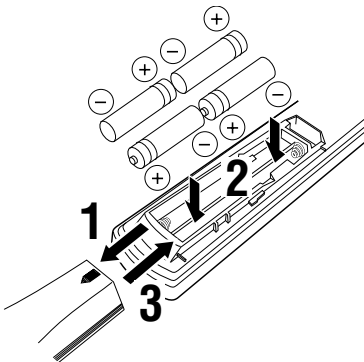

Notes on batteries

- Change the batteries periodically.
- Do not use old batteries together with new ones.
- Do not use different types of batteries (such as alkaline and manganese batteries) together. Read the packaging carefully as these different types of batteries may have the same shape and color.

Changing batteries

As the batteries lose power, the operating range of the remote control decreases and the indicator does not flash or its light becomes dim. When you notice any of these conditions, change all of the batteries.

If the remote control is without batteries for more than 2 minutes, or if exhausted batteries remain in the remote control, the contents of the memory may be cleared. When the memory is cleared, insert new batteries, set up the manufacturer code that may have been cleared.

Note

- If the batteries have leaked, dispose of them immediately. Avoid touching the leaked material or letting it come into contact with clothing, etc. Clean the battery compartment thoroughly before installing new batteries.

CONTROLS AND FUNCTIONS

Front Panel

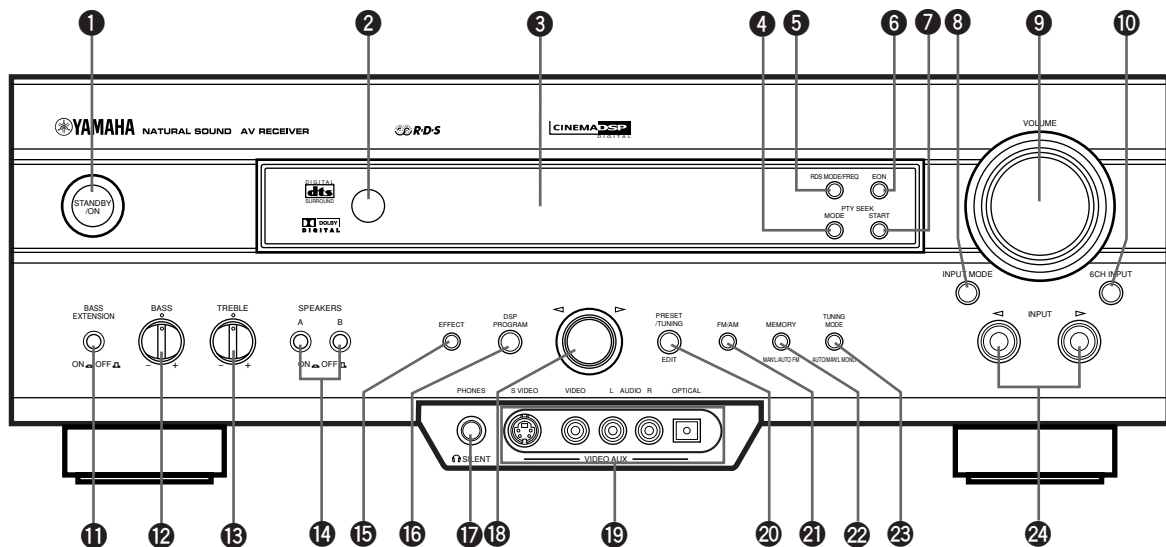

1 STANDBY/ON

Turns on or sets this unit in the standby mode. When you turn on this unit, you will hear a click and there will be a 4 to 5-second delay before this unit can reproduce sound.

Standby mode

In this mode, this unit consumes a small amount of power to receive infrared-signals from the remote control.

2 Remote control sensor

Receives signals from the remote control.

3 Front panel display

Shows information about the operational status of this unit.

4 PTY SEEK MODE

Sets the unit in the PTY SEEK mode.

5 RDS MODE/FREQ

When an RDS station is received, press this button to change the display mode among the PS mode, PTY mode, RT mode, CT mode (if the station offers those RDS data services) and/or frequency display mode in turn.

6 EON

Selects the desired program type (NEWS, INFO, AFFAIRS, SPORT) when you want to tune in to a radio program of that type automatically.

7 PTY SEEK START

Begins searching for a station after the desired program type has been selected in the PTY SEEK mode.

8 INPUT MODE

Selects the mode of input for sources that send two or more types of signals to this unit (see page 26 for details). You cannot control the input mode when you select 6CH INPUT as the input source.

9 VOLUME

Controls the output level of all audio channels. This does not affect the REC OUT level.

10 6CH INPUT

Selects the source connected to the 6CH INPUT jacks. The source selected by pressing 6CH INPUT takes priority over the source selected with INPUT </> (or the input selector buttons on the remote control).

11 BASS EXTENSION ON/OFF

When pushed in (ON), this feature boosts the bass frequency of the left and right main speakers by +6 dB (60 Hz) while maintaining overall tonal balance. This boost is useful if you do not use a subwoofer. However, this boost may not be noticeable if "1B MAIN SP" on the SET MENU is set to SMALL and "1D LFE/BASS OUT" is set to SWFR.

12 BASS

Adjusts the low-frequency response for the left and right main speakers.

Turn the control to the right to increase or to the left to decrease the low-frequency response.

13 TREBLE

Adjusts the high-frequency response for the left and right main speakers.

Turn the control to the right to increase or to the left to decrease the high-frequency response.

Note

- If you increase or decrease the high-frequency or the low-frequency sound to an extreme level, the tonal quality from the center and rear speakers may not match that of the left and right main speakers.

14 SPEAKERS A/B

When pushed in (ON), these buttons turn on the set of main speakers connected to the A and/or B terminals on the rear panel.

15 EFFECT

Switches the effect speakers (center and rear) on and off. If you turn off the output of these speakers by using EFFECT, all Dolby Digital and DTS audio signals except for the LFE channel are directed to the main left and right channels.

When Dolby Digital or DTS signals are mixed, the left and right main channel signal levels may not match.

16 DSP PROGRAM

Switches the function of the multi jog knob for selecting DSP program.

17 PHONES jack

Outputs audio signals for private listening with headphones. When you connect headphones, no signals are output to the OUTPUT jacks or to the speakers.

18 Multi jog knob

Selects the tuning frequency in the tuning mode.

Selects the preset station after pressing PRESET/TUNING (EDIT) to display “>`” in the tuning mode.

Selects the DSP program after pressing DSP PROGRAM.

19 VIDEO AUX jacks

Inputs audio and video signals from a portable external source such as a game console. To reproduce source signals from these jacks, select V-AUX as the input source.

20 PRESET/TUNING (EDIT)

Switches the function of the multi jog knob between selecting a preset station number and tuning.

This button is also used to exchange the assignment of two preset stations with each other.

21 FM/AM

Switches the reception band between FM and AM.

22 MEMORY (MAN'L/AUTO FM)

Stores a station in the memory. Hold down this button for more than 3 seconds to start automatic preset tuning (for FM stations only).

23 TUNING MODE (AUTO/MAN'L MONO)

Switches the tuning mode between automatic and manual. To select the automatic tuning mode, press this button so that the “AUTO” indicator lights up on the front panel display again. To select the manual tuning mode, press this button so that the “AUTO” indicator does not light up.

24 INPUT ◀ / ▶

Selects the input source (CD, TUNER, MD/CD-R, DVD, D-TV/CBL, VCR 1, PHONO, V-AUX, VCR 2/DVR) you want to listen to or watch.

Remote Control

This section describes the basic operation of this unit with the remote control. First, set the selector dial to the AMP/TUN position. See “REMOTE CONTROL FEATURES” for full details.

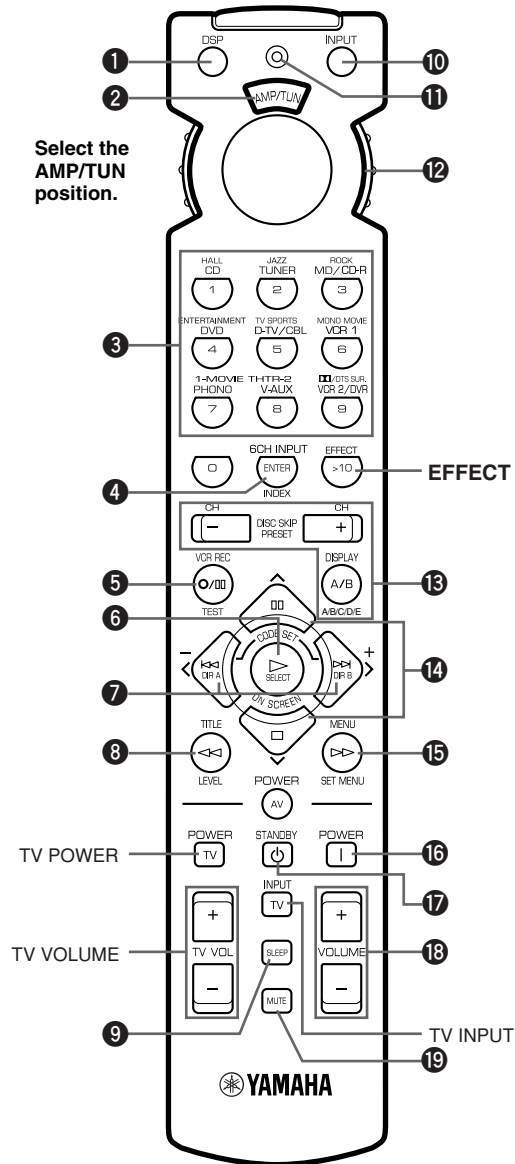

- 1 DSP**
Switches the function of the numeric buttons to the DSP program selector.
- 2 Indicator window**
Shows the name of components which can be controlled.

3 Numeric buttons (Input selector buttons)

These buttons select the input source.
See “Description of the Numeric Buttons” for the numeric buttons.

4 6CH INPUT

Selects the source connected to the 6CH INPUT jacks.

5 TEST

Outputs the test tone.

6 ON SCREEN

Selects the on-screen display (OSD) mode for your video monitor.

7 </> (-/+)

Adjust DSP program parameters and SET MENU items.
-/+ is displayed on the on-screen display.

8 LEVEL

Selects the effect speaker channel (center, rear and subwoofer) so you can adjust their output level independently.

9 SLEEP

Sets the sleep timer.

10 INPUT

Switches the function of the numeric buttons to the input selector.

11 Indicator

Flashes while the remote control is sending signals.

12 Selector dial

Turn this dial to select the position for the component to be controlled. (The proper code must be set up for your component. See “Setting the Manufacture Codes”.) When a position is selected, the remote control is set to that component operation mode.

13 A/B/C/D/E, PRESET -/+

These buttons are used to select a preset station.

A/B/C/D/E: To select one of 5 preset station groups (A to E)

PRESET -/+ : To select a preset station number (1 to 8)

14 ^/v

Select DSP program parameters and SET MENU items.

15 SET MENU

Enters the SET MENU.

16 POWER

Turns on the power of this unit.

17 STANDBY

Sets this unit in the standby mode.

18 VOLUME +/-

Increases or decreases the volume level.

19 MUTE

Mutes the sound. Press again to restore the audio output to the previous volume level.

EFFECT

Switches the effect speakers (center and rear) on and off in the following cases:

- When the selector dial is set to the DSP/TUN position.
- While the indicator is lit for about 3 seconds after pressing DSP.

Description of the Numeric Buttons

The numeric buttons function in various ways depending on the position of the selector dial or the combination of other instructions.

When selecting an input source

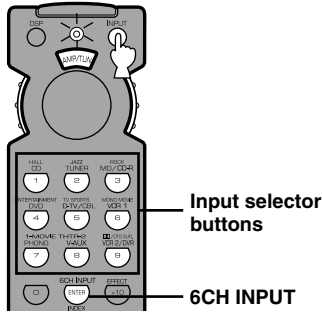

1 Press INPUT regardless of the position of the selector dial. The indicator lights up for about 3 seconds.

2 You can select an input source with the numeric buttons and 6CH INPUT while the indicator is lit.

When selecting a DSP program and turning on or off the effect speakers (center and rear)

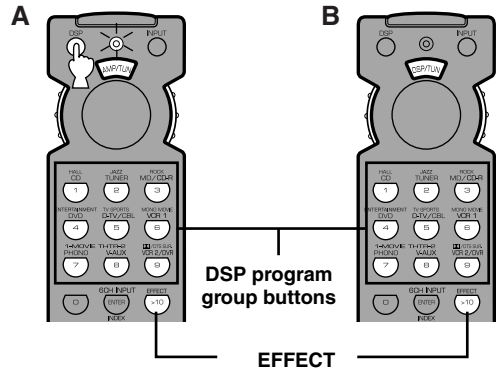

A

1 Press DSP regardless of the position of the selector dial. The indicator lights up for about 3 seconds.

2 You can select a DSP program with the numeric buttons and turn on or off the effect speakers (center and rear) by pressing EFFECT while the indicator is lit.

B

1 Set the selector dial to the DSP/TUN position.

2 You can select a DSP program directly with the numeric buttons and turn on or off the effect speakers (center and rear) by pressing EFFECT.

■ When selecting a preset station number

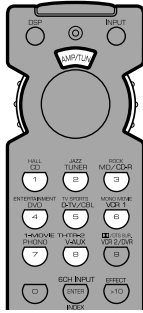

- 1** Set code number “0023” in the AMP/TUN (or DSP/TUN) position.
See “Setting the Manufacturer Code” for setting the code.
- 2** Set the selector dial to the AMP/TUN (or DSP/TUN) position.
- 3** You can select a preset station number directly with the numeric buttons (1 to 8).
See “Tuning in to a Preset Station”.

Using the Remote Control

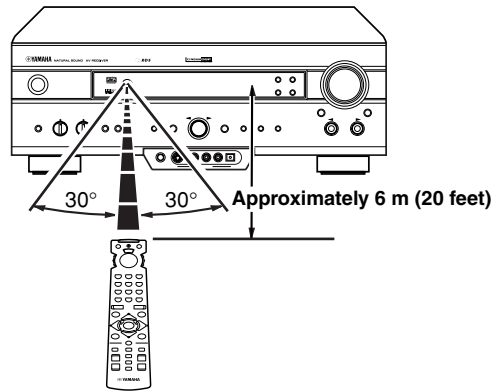

The remote control transmits a directional infrared beam. Be sure to aim the remote control directly at the remote control sensor on the main unit during operation.

■ Handling the remote control

- Do not spill water or other liquids on the remote control.
- Do not drop the remote control.
- Do not leave or store the remote control in the following types of conditions:
 - high humidity or temperature such as near a heater, stove or bath;
 - dusty places; or
 - in places subject to extremely low temperatures.

Front Panel Display

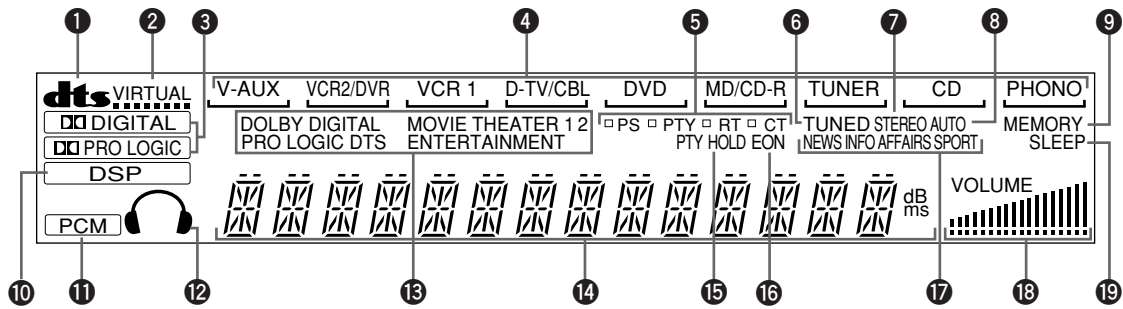

1 dts indicator

Lights up when the built-in DTS decoder is on.

2 VIRTUAL indicator

Lights up when using Virtual CINEMA DSP.

3 DIGITAL and PRO LOGIC indicators

Light up according to the type of Dolby signals this unit is reproducing. “DIGITAL” lights up when the built-in Dolby Digital decoder is on. “PRO LOGIC” lights up when the built-in Dolby Pro Logic decoder is on.

4 Input source indicator

Shows the current input source with a cursor.

5 RDS mode indicators

The name(s) of the RDS data offered by the currently received RDS station light(s) up. Illumination of the red indicator next to the RDS data name shows that the corresponding RDS mode is now selected.

6 TUNED indicator

Lights up when this unit tunes in to a station.

7 STEREO indicator

Lights up when the unit is receiving a strong signal for an FM stereo broadcast while the “AUTO” indicator is lit.

8 AUTO indicator

Shows that this unit is in the automatic tuning mode.

9 MEMORY indicator

Flashes to show a station can be stored.

10 DSP indicator

Lights up when you select a DSP program.

11 PCM indicator

Lights up when this unit is reproducing PCM (pulse code modulation) digital audio signals.

12 Headphones indicator

Lights up when headphones are connected.

13 DSP program indicators

The name of the selected DSP program lights up when the ENTERTAINMENT, MOVIE THEATER 1, MOVIE THEATER 2 or DOLBY/DTS SURROUND DSP program is selected.

14 Multi-information display

Shows the current DSP program name and other information when adjusting or changing settings.

15 PTY HOLD indicator

Lights up while searching for stations in the PTY SEEK mode.

16 EON indicator

Lights up when an RDS station that offers the EON data service is being received.

17 Program type name indicators

The name of the selected program type lights up when the “EON” indicator lights up.

18 VOLUME level indicator

Indicates the volume level.

19 SLEEP indicator

Lights up while the sleep timer is on.

Rear Panel

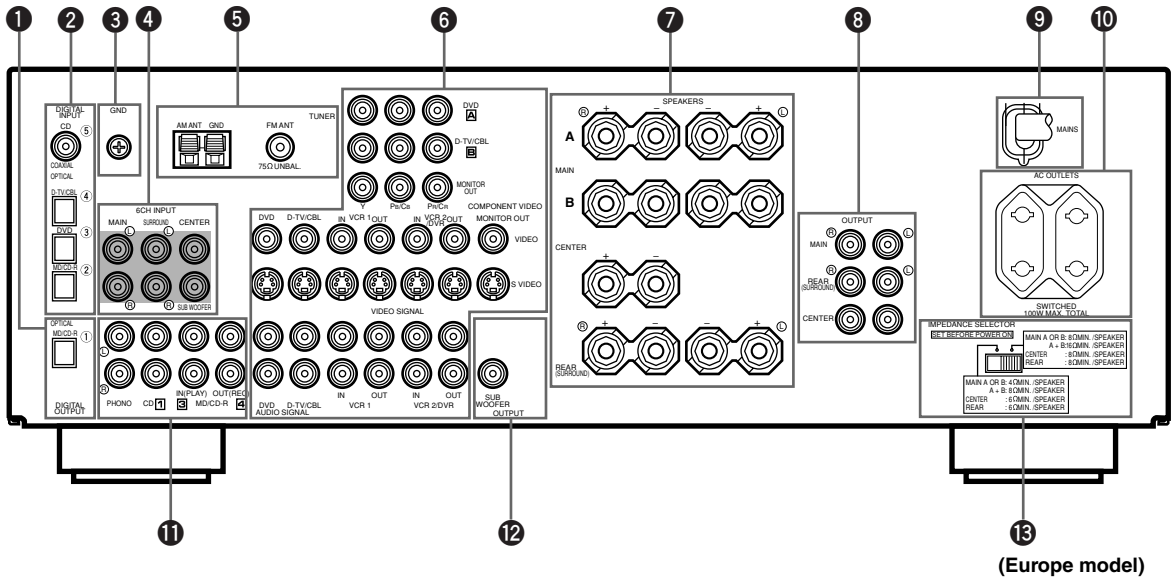

(Europe model)

1 DIGITAL OUTPUT jacks

2 DIGITAL INPUT jacks

3 GND terminal

See page 12 for connection information.

4 6CH INPUT jacks

See pages 13 and 18 for connection information.

5 Antenna input terminals

See page 30 for connection information.

6 Video component jacks

See pages 14 and 15 for connection information.

7 Speaker terminals

See pages 16 and 17 for connection information.

8 OUTPUT jacks

See page 18 for connection information.

9 AC power cord

Connect to a power outlet.

10 AC OUTLET(S)

Use these outlets to supply power to your other audio/video components (see page 19).

11 Audio component jacks

See pages 12 and 13 for connection information.

12 SUBWOOFER jack

See page 17 for connection information.

13 IMPEDANCE SELECTOR switch

Use this switch to match the amplifier output to your speaker impedance. Set this unit in the standby mode before you change the setting of this switch (see page 19).

SPEAKER SETUP

Speakers to Be Used

This unit has been designed to provide the best sound-field quality with a 5-speaker system, using left and right main speakers, left and right rear speakers, and a center speaker. If you use different brands of speakers (with different tonal qualities) in your system, the tone of a moving human voice and other types of sound may not shift smoothly. We recommend that you use speakers from the same manufacturer to ensure even tonal quality.

The main speakers are used for the main source sound plus the effect sounds. They will probably be the speakers from your present stereo system. The rear speakers are used for the effect and surround sounds, and the center speaker is for the center sounds (dialog, vocals, etc.). If for some reason it is not practical to use a center speaker, you can do without it. Best results, however, are obtained with the full system.

The main speakers should be high-performance models and have enough power-handling capacity to accept the maximum output of your audio system. The other speakers do not have to be equal to the main speakers. For precise sound localization, however, it is ideal to use high-performance models that can reproduce sounds over the full range for the center speaker and the rear speakers.

■ Use of a subwoofer expands your sound field

It is also possible to further expand your system with the addition of a subwoofer. The use of a subwoofer is effective not only for reinforcing bass frequencies from any or all channels, but also for reproducing the LFE (low-frequency effect) channel with high fidelity when the Dolby Digital signal or the DTS signal is played back. The YAMAHA Active Servo Processing Subwoofer System is ideal for natural and lively bass reproduction.

Speaker Placement

Refer to the following diagram when you place the speakers.

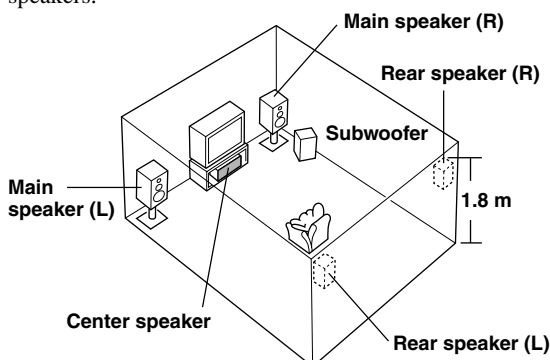

■ Main speakers

Place the left and right main speakers an equal distance from the ideal listening position. The distance of each speaker from each side of the video monitor should be the same.

■ Rear speakers

Place these speakers behind your listening position, facing slightly inwards, nearly 1.8 m (approx. 6 feet) above the floor.

■ Center speaker

Align the front face of the center speaker with the front face of your video monitor. Place the speaker as close to the monitor as possible, such as directly over or under the monitor and centrally between the main speakers.

Note

- If the center speaker is not used, the center channel sound will be heard from the left and right main speakers. In this case, "1A CENTER SP" on the SET MENU is set to NONE.

■ Subwoofer

The position of the subwoofer is not so critical, because low bass sounds are not highly directional. But it is better to place the subwoofer near the main speakers. Turn it slightly toward the center of the room to reduce the wall reflections.

CAUTION

Please use magnetically shielded speakers. Sometimes a video monitor may be adversely affected even when magnetically shielded speakers are used. Separate the speakers from the monitor if this happens.

CONNECTIONS

Before Connecting Components

CAUTION

Never connect this unit and other components to mains power until all connections between components have been completed.

- Be sure all connections are made correctly, that is to say L (left) to L, R (right) to R, “+” to “+” and “-” to “-”. Some components require different connection methods and have different jack names. Refer to the operation instructions for each component to be connected to this unit.
- When you connect other YAMAHA audio components (such as a tape deck, MD recorder and CD player or changer), connect them to the jack with the same number labels as **1**, **3**, **4** etc.
- After you have completed all connections, check them again to make sure they are correct.

Connecting Audio Components

■ Connecting to digital jacks

This unit has digital jacks for direct transmission of digital signals through either coaxial or fiber optic cables. You can use the digital jacks to input PCM, Dolby Digital and DTS bitstreams. When you connect components to both the COAXIAL and OPTICAL jacks, priority is given to the input signals from the COAXIAL jack. All digital input jacks are acceptable for 96-kHz sampling digital signals.



- You can designate the input for each digital jack according to your component by using “4 I/O ASSIGNMENT” on the SET MENU.

About the dust protection cap

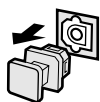

Pull out the cap from the optical jack before you connect the fiber optic cable. Do not discard the cap. When you are not using the optical jack, be sure to put the cap back in place. This cap protects the jack from dust.

Note

- The OPTICAL jacks on this unit conform to the EIA standard. If you use a fiber optic cable that does not conform to this standard, this unit may not function properly.

■ Connecting a turntable

PHONO jacks are for connecting a turntable with an MM or high-output MC cartridge. If you have a turntable with a low-output MC cartridge, use an inline boosting transformer or MC-head amplifier when connecting to these jacks.



- The GND terminal does not electrically ground the turntable. It simply reduces noise in the signal. In some cases, you may hear less noise if you do not connect to the GND terminal.

■ Connecting a CD player



- The COAXIAL jack is available for a CD player which has a coaxial digital output jack.
- When you connect a CD player to both the analog and digital jacks, priority is given to the input signals from the digital jack.

■ Connecting an MD recorder, CD recorder or tape deck



- When you connect your recording component to both the analog and digital input and output jacks, the priority is given to the digital signal.

Notes

- When you connect a recording component to this unit, keep its power on while using this unit. If the power is off, this unit may distort the sound from other components.
- Since digital output and analog output (REC OUT) are independent of each other, the analog signal is output only to the analog jack, while the digital signal is output only to the digital jack.

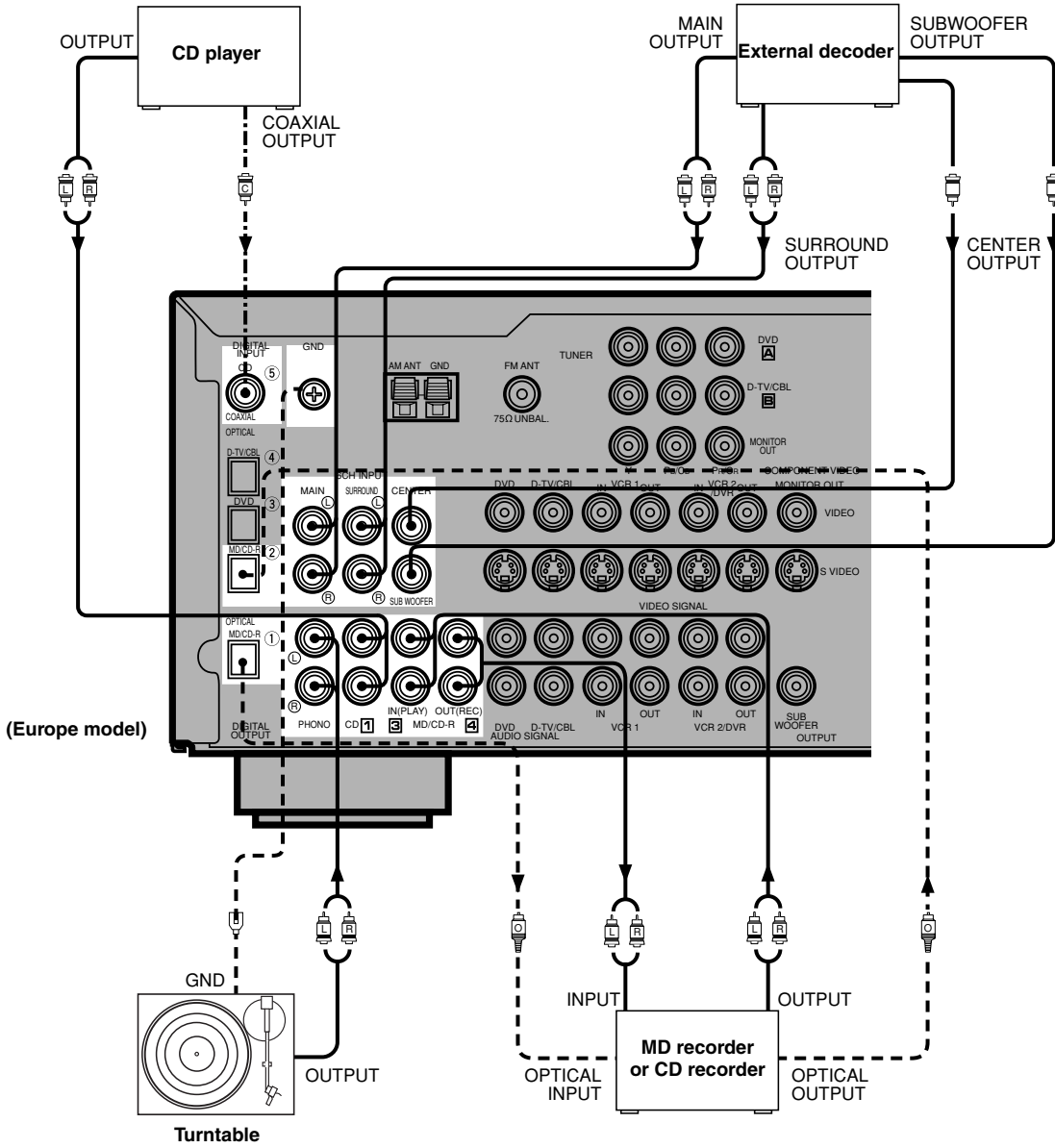

PREPARATION

English

Connecting Video Components

About the video jacks

There are three types of video jacks. Video signals input through the VIDEO jacks are the conventional composite video signals. Video signals input through the S VIDEO jacks are separated into luminance (Y) and color (C) video signals. The S-video signals achieve high-quality color reproduction. Video signals input through the COMPONENT VIDEO jacks are separated into luminance (Y) and color difference (P_B/C_B, P_R/C_R) video signals. The jacks are also separated into three for each signal. The description of the component video jacks may be different depending on the component (e.g. Y, C_B, C_R/Y, P_B, P_R/Y, B-Y, R-Y etc.). Component video signals provide the best quality in picture reproduction.

If your video component has an S-video output or component video output, you can connect it to this unit. Connect the S-video signal output jack on your video component to the S VIDEO jack or connect the component signal output jacks on your video component to the COMPONENT VIDEO jacks.



VIDEO jack (composite)



S VIDEO jack



COMPONENT VIDEO jacks



- Each type of video jack works independently. Signals input through the composite video, S-video and component jacks are output through the corresponding composite video, S-video, and component jacks, respectively.
- If you make S-video connections to this unit, it is not necessary to make composite video connections. If both types of connections are made, this unit gives priority to the S-video signal.
- You can designate the input for the COMPONENT VIDEO A and B jacks according to your component by using "4 I/O ASSIGNMENT" on the SET MENU.

Notes

- Use a commercially available S-video cable when connecting to the S VIDEO jack, and commercially available video cables when connecting to the COMPONENT VIDEO jacks.
- When you are using the COMPONENT VIDEO jacks, check the details in the owner's manual that came with the component being connected.

Video monitor with a 21-pin connector

Make a connection as shown on page 15 with a commercially available SCART-plug connector cable.

VIDEO AUX jacks (on the front panel)

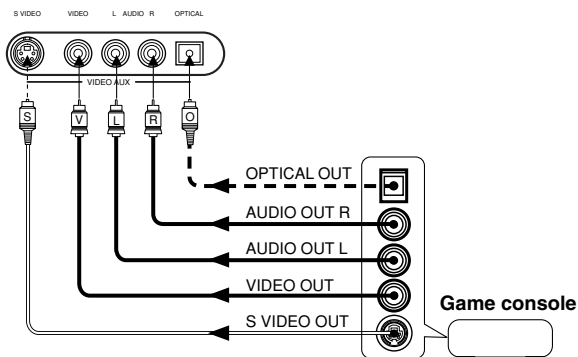

These jacks are used to connect any video input source such as a game console to this unit.

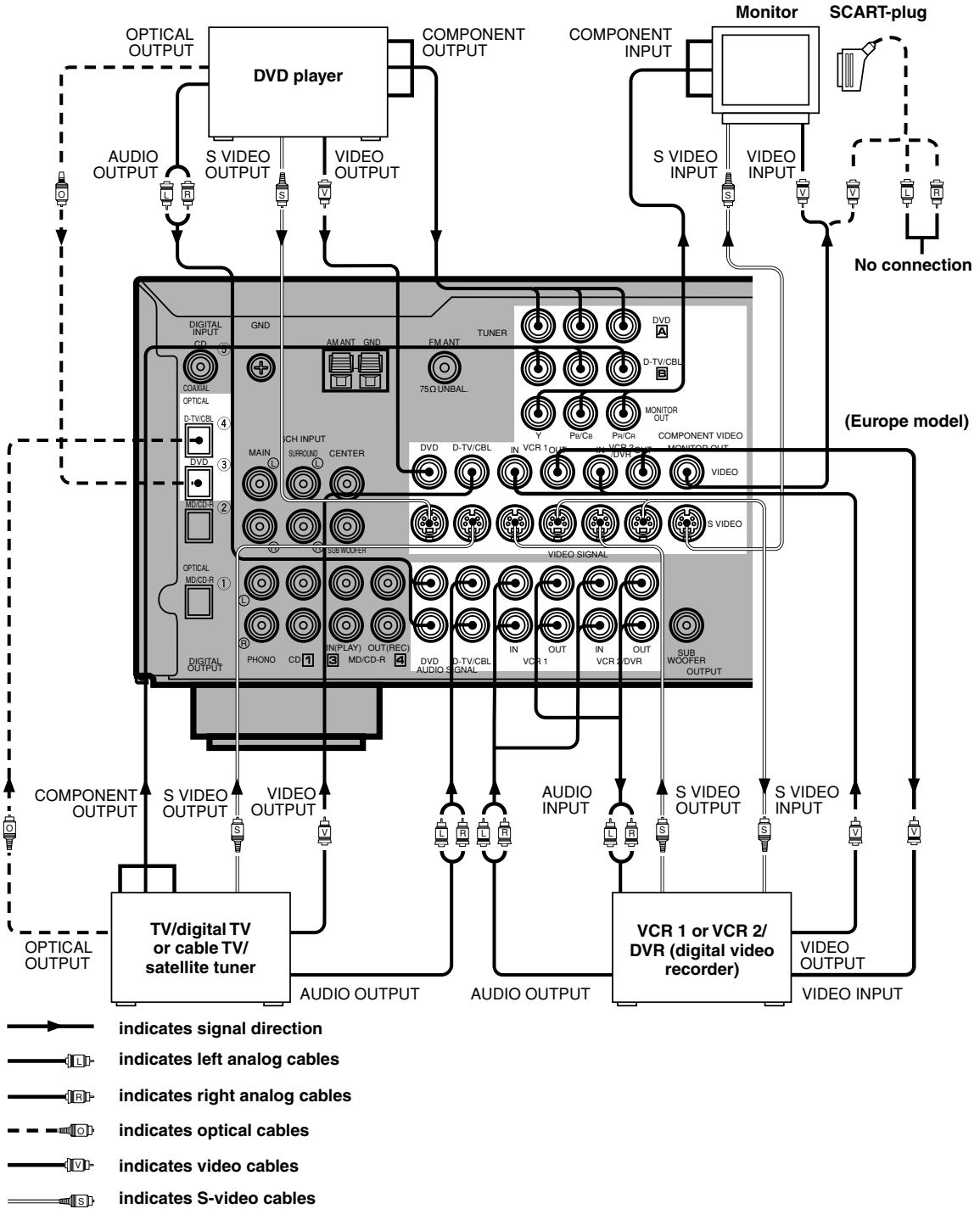

When using an LD player

Connect the LD player output to the DVD jack.

If the LD player has an OPTICAL digital output jack, connect it to this unit's OPTICAL DVD jack. If it has analog jacks, connect it to the analog DVD jacks. If it has an "RF OUTPUT jack" to output a Dolby Digital RF signal (AC-3), use a commercially available RF demodulator and connect it to the OPTICAL DVD jack.

If connecting a DVD player and an LD player, connect the LD player to the digital input jack (ex. D-TV/CBL) or to the analog input jack (D-TV/CBL, VCR 1 or VCR 2/DVR). For details on connections and operations, refer to the instruction manual for the LD player.

Note that this unit's remote control can be used to operate the LD player by setting the corresponding manufacturer code for the DVD/LD position.

Connecting the Speakers

Be sure to connect the left channel (L), right channel (R), “+” (red) and “-” (black) properly. If the connections are faulty, no sound will be heard from the speakers, and if the polarity of the speaker connections is incorrect, the sound will be unnatural and lack bass.

CAUTION

- Use speakers with the specified impedance shown on the rear panel of this unit.
- Do not let the bare speaker wires touch each other and do not let them touch any metal part of this unit. This could damage the unit and/or speakers.

If necessary, use the SET MENU to change the speaker mode settings according to the number and size of the speakers in your configuration after you finish connecting your speakers.

■ Speaker cables

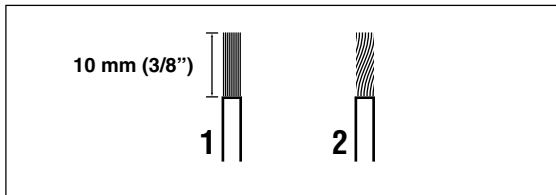

A speaker cord is actually a pair of insulated cables running side by side. One of the cables is colored or shaped differently, perhaps with a stripe, groove or ridge.

- 1** Remove approx. 10 mm (3/8”) of insulation from each of the speaker cables.
- 2** Twist the exposed wires of the cable together to prevent short circuits.

■ Connecting to the SPEAKERS terminals

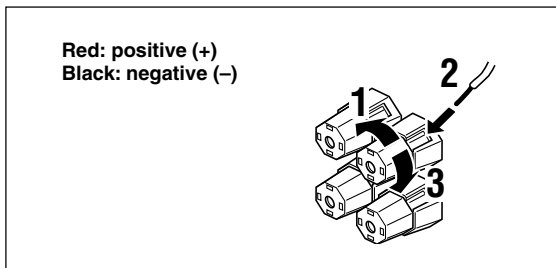

Red: positive (+)
Black: negative (-)

- 1** Unscrew the knob.
- 2** Insert one bare wire into the hole in the side of each terminal.
- 3** Tighten the knob to secure the wire.

■ MAIN SPEAKERS terminals

One or two speaker systems can be connected to these terminals. If you use only one speaker system, connect it to either of the MAIN A or B terminals.

■ REAR SPEAKERS terminals

A rear speaker system can be connected to these terminals.

■ CENTER SPEAKER terminals

A center speaker can be connected to these terminals.

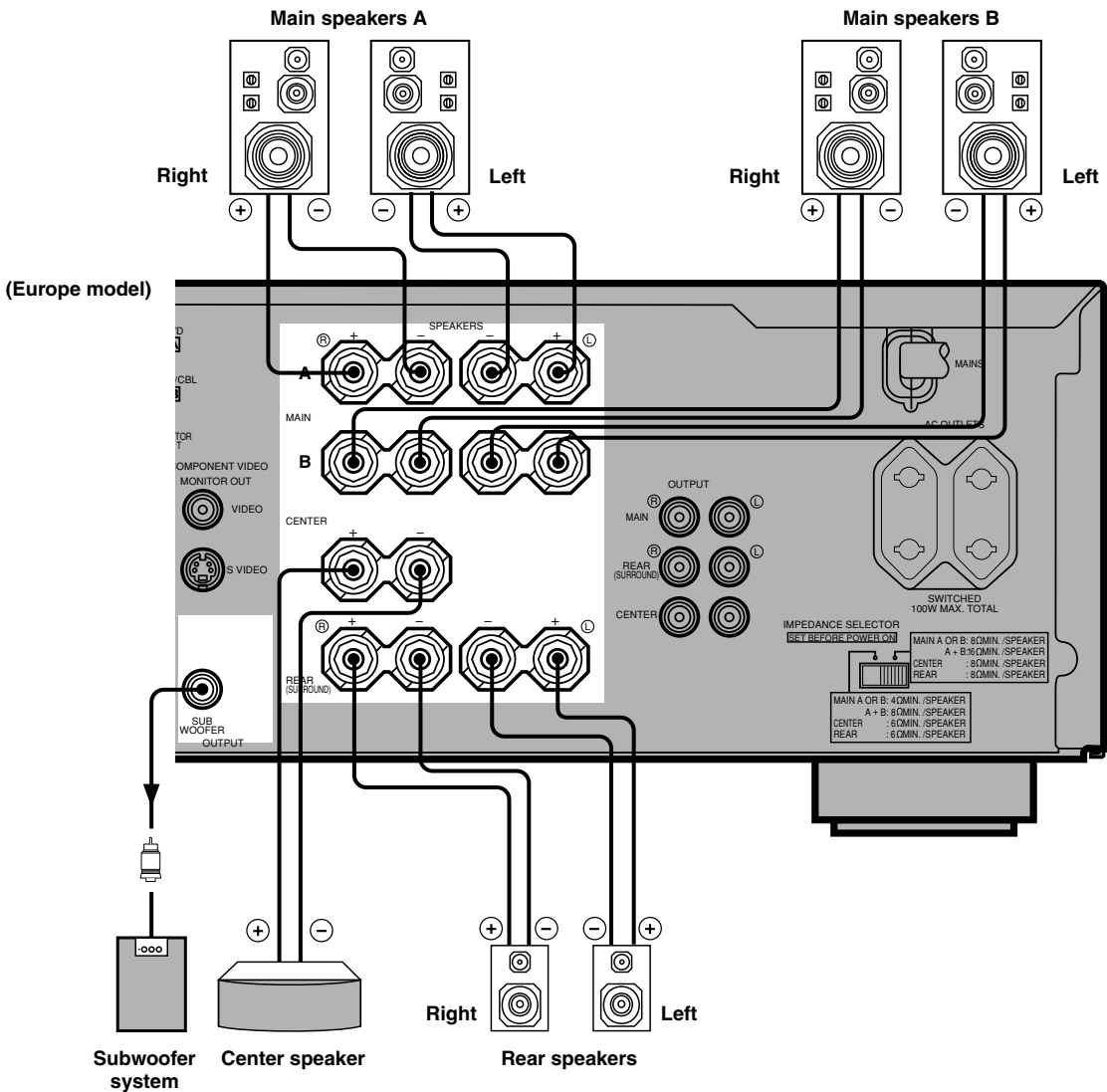

PREPARATION

■ SUBWOOFER jack

When using a subwoofer with built-in amplifier, including the YAMAHA Active Servo Processing Subwoofer System, connect the input jack of the subwoofer system to this jack. Low bass signals distributed from the main, center and/or rear channels are directed to this jack. (The cut-off frequency of this jack is 90 Hz.) The LFE (low-frequency effect) signals generated when Dolby Digital or DTS is decoded are also directed if they are assigned to this jack.

Notes

- Adjust the subwoofer volume according to the operating instructions for the subwoofer. (Fine adjustment is possible using this unit's output level control of the effect speakers.)
- Depending on the settings of "1 SPEAKER SET", "6 DOLBY D. SET" and "7 DTS SET" on the SET MENU, some signals may not be output from the SUBWOOFER jack.

English

Connecting an External Amplifier

If you want to increase the power output to the speakers, or want to use another amplifier, connect an external amplifier to the OUTPUT jacks as follows.

Note

- When RCA pin plugs are connected to the OUTPUT jacks for output to an external amplifier, do not use the corresponding SPEAKERS terminals.

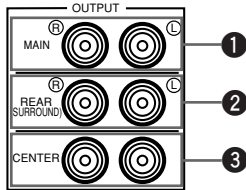

1 MAIN jacks

Main channel line output jacks.

Note

- The signals output through these jacks are affected by the BASS, TREBLE and BASS EXTENSION settings.

2 REAR (SURROUND) jacks

Rear channel line output jacks.

3 CENTER jacks

Center channel line output jacks.

Connecting an External Decoder

This unit is equipped with 6 additional input jacks (left and right MAIN, CENTER, left and right SURROUND and SUBWOOFER) for discrete multi-channel input from an external decoder, sound processor or pre-amplifier.

Connect the output jacks on your external decoder to the 6CH INPUT jacks. Be sure to match the left and right outputs to the left and right input jacks for the main and surround channels.

Notes

- When you select 6CH INPUT as the input source, this unit automatically turns off the digital sound field processor, and you cannot listen to DSP programs.
- When you select 6CH INPUT as the input source, changing items 1A to 1E on the SET MENU is not affected.

IMPEDANCE SELECTOR Switch

WARNING

Do not change the IMPEDANCE SELECTOR switch setting while the power of this unit is on, otherwise the unit may be damaged.
 If this unit fails to turn on when STANDBY/ON (or POWER) is pressed, the IMPEDANCE SELECTOR switch may not be fully slid to either position. If so, slide the switch to either position fully when this unit is in the standby mode.

Select the left or right position according to the impedance of the speakers in your system. Be sure to move this switch only when this unit is in the standby mode.

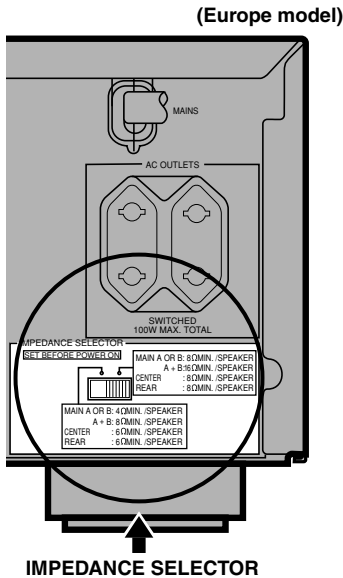

Switch position	Speaker	Impedance level
Left	Main	If you use one set of main speakers, the impedance of each speaker must be 4 Ω or higher.
		If you use two sets of main speakers, the impedance of each speaker must be 8 Ω or higher.
	Center	The impedance must be 6 Ω or higher.
	Rear	The impedance of each speaker must be 6 Ω or higher.
Right	Main	If you use one set of main speakers, the impedance of each speaker must be 8 Ω or higher.
		If you use two sets of main speakers, the impedance of each speaker must be 16 Ω or higher.
	Center	The impedance must be 8 Ω or higher.
	Rear	The impedance of each speaker must be 8 Ω or higher.

PREPARATION

Connecting the Power Supply Cords

After completing all connections, connect the AC power cord to an AC power outlet. Disconnect the AC power cord if you will not use this unit for a long period of time.

AC OUTLET(S) (SWITCHED)

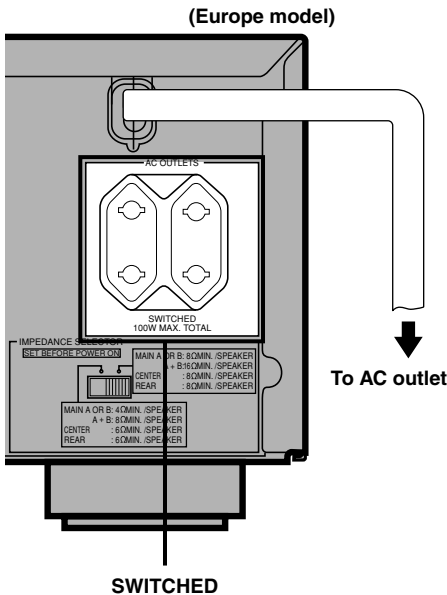

Europe model 2 OUTLETS
 U.K. model 1 OUTLET
 Use these outlets to connect the power cords only from your audio/video components to this unit. The power to the AC OUTLET(S) is controlled by this unit's STANDBY/ON (or POWER and STANDBY). These outlets will supply power to any connected component whenever this unit is turned on. The maximum power (total power consumption of components) that can be connected to the AC OUTLET(S) is 100 W.

English

ON-SCREEN DISPLAY (OSD)

You can display the operation information for this unit on a video monitor. If you display the SET MENU and DSP program parameter settings on a monitor, it is much easier to see the available options and parameters than it is by reading this information on the front panel display.



- If a video source is being reproduced, the OSD is superimposed over the image.
- The OSD signal is not output to the REC OUT jack, and will not be recorded with any video signal.
- You can set the OSD to turn on (blue background) or off when a video source is not being reproduced (or the source component is turned off) by using “9 DISPLAY SET” on the SET MENU.

OSD Modes

You can change the amount of information the OSD shows.

Full display

This mode always shows the DSP program parameter settings on the video monitor.

Short display

This mode briefly shows the same contents as the front panel display at the bottom of the screen and then disappears.

Display off

This mode briefly shows the “DISPLAY OFF” message at the bottom of the screen and then disappears. Afterwards, no changes to operations appear on the monitor except those of the ON SCREEN button.

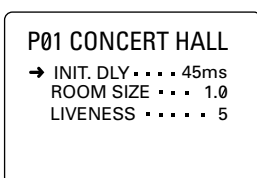

Full display

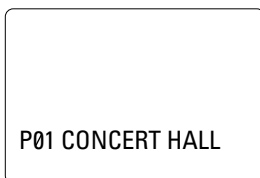

Short display



- When you choose the full display mode, INPUT </>, VOLUME and some other types of operation information are displayed at the bottom of the screen in the same format as that for the front panel display.
- The SET MENU and test tone display appear regardless of the OSD mode.

Selecting the OSD Mode

1 When you turn on the power, the video monitor and front panel display show the level of the main volume for a few seconds and then switch to show the current DSP program.

2 Press ON SCREEN on the remote control repeatedly to change the display mode.

The OSD mode changes in the following order: full display, short display, and display off.

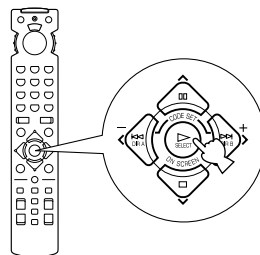

Notes

- If you choose a video input source that has a component connected to both the S VIDEO IN and composite VIDEO IN jacks, and both the S VIDEO OUT and composite VIDEO OUT jacks are connected to a video monitor, the video signal is output to both the S VIDEO OUT and VIDEO OUT jacks. However, the OSD is carried only on the S-video signal. If no video signal is input, the OSD is carried on both the S-video and composite video signals.
- If your video monitor is connected only to the COMPONENT VIDEO jacks of this unit, the OSD is not shown. Make sure to connect your video monitor to the COMPONENT VIDEO jacks and either VIDEO or S VIDEO jacks if you want to see the OSD.
- Playing back video software that has an anti-copy signal or video signals with a lot of noise may produce unstable images.

SPEAKER MODE SETTINGS

This unit is equipped with a main amplifier capable of handling 5.1 channel. Although up to 6 speakers can be connected, it is possible to select the speaker mode that gives the best sound field effect according to the number and size of speakers being used.

Before use, please set the speaker mode setting using “1 SPEAKER SET” on the SET MENU described on page 39.

Summary of SPEAKER SET Items 1A through 1E

Item	Description	Control value (default setting indicated in bold)
1A CENTER SP	Selects the output mode according to whether or not a center speaker is being used and its performance.	LRG /SML/NONE
1B MAIN SP	Selects the output mode according to the performance of the main speakers.	LARGE /SMALL
1C REAR L/R SP	Selects the output mode according to whether or not rear L/R speakers are being used and their performance.	LRG /SML/NONE
1D LFE/BASS OUT	Selects the speaker according to use for LFE signal output and low bass signal.	SWFR/ MAIN / BOTH
1E MAIN LEVEL	Selects the main speaker level.	Normal /-10 dB

ADJUSTING THE SPEAKER OUTPUT LEVELS

This section explains how to adjust the speaker output levels by using the test tone generator. When this adjustment is made, the output level heard at the listening position will be the same from each speaker. This is important for the best performance of the digital sound field processor, the Dolby Pro Logic decoder, Dolby Digital decoder and DTS decoder.

Note

- Since this unit cannot enter the test mode while headphones are connected to this unit, be sure to unplug the headphones from the PHONES jack when using the test tone.

Before You Begin

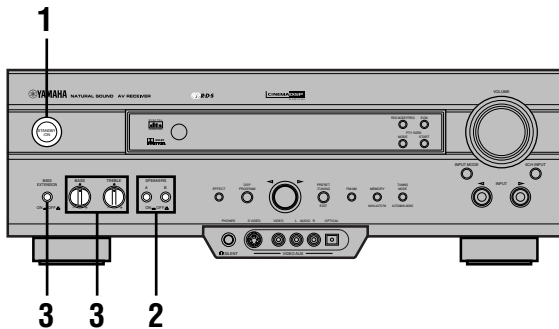

- 1 Press **STANDBY/ON** to turn on the power. Turn on the video monitor.



- 2 Press **SPEAKERS A** or **B** to select the main speakers to be used.

If you are using two sets of the main speakers, press both A and B.

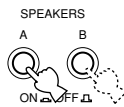

- 3 Set **BASS** and **TREBLE** on the front panel to the center position and set **BASS EXTENSION** to OFF.

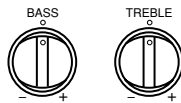

Using the Test Tone (TEST DOLBY SUR.)

The adjustment of each speaker output level should be made at your listening position with the remote control.

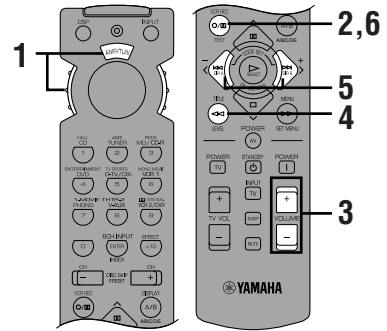

- 1 Set the selector dial to the **AMP/TUN** (or **DSP/TUN**) position.



- 2 Press **TEST** to output the test tone.



- 3 Adjust the volume so you can hear the test tone.

The test tone is heard from the left main speaker, center speaker, right main speaker, right rear speaker and left rear speaker in order. The tone is produced for 2.5 seconds each time.

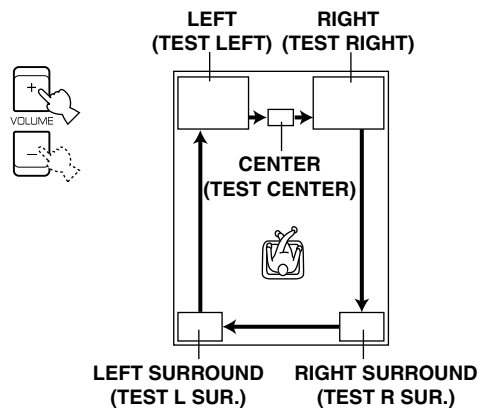

The state of the test tone output is also shown on the monitor by an image of the audio listening room. This is convenient for adjusting each speaker level.

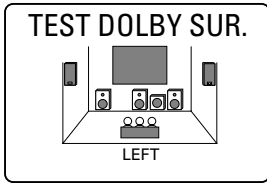

- If “1A CENTER SP” on the SET MENU is set to NONE, the center channel sound is automatically output from the left and right main speakers.

Note

- If the test tone cannot be heard, turn down the volume, set the unit in the standby mode and check the speaker connections.

4 Press LEVEL repeatedly to select the speaker to be adjusted.



- Once you press LEVEL, you can also select the speaker to be adjusted by pressing ∨. (Pressing ∧ changes the selection in the reverse order.)

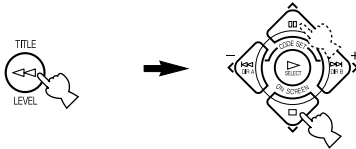

5 Press </> repeatedly to adjust the output level of the currently selected speaker so that it becomes almost the same as that of the main speaker.

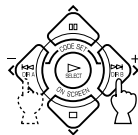

- While adjusting, the test tone is heard from the selected speaker.
- Repeat steps 4 and 5 to adjust the output levels of the center, left rear and right rear speakers.

6 When the adjustment is complete, press TEST.

The test tone stops and the current DSP program appears on the front panel display and on the video monitor.



Notes

- For details on adjusting the subwoofer speaker, refer to the effect speaker level adjustment described on page 46.
- After adjusting with the test tone, it is possible to adjust the speaker level to taste while listening to the playback of an actual source when using the effect speaker level adjustment described on page 46.



- You can increase the output levels of the effect speakers (center, left rear and right rear) to +10 dB. If the output level of these speakers is lower than that of the main speakers even after you have increased the output level of these speakers up to +10 dB, set “1E MAIN LEVEL” on the SET MENU to -10 dB. This setting decreases the main speaker output level to about one-third of the normal level. After you have set “1E MAIN LEVEL” on the SET MENU to -10 dB, adjust the levels for the center and rear speakers again.

BASIC PLAYBACK

When using the remote control, set the selector dial to the AMP/TUN position.

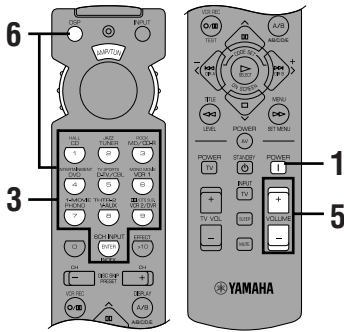
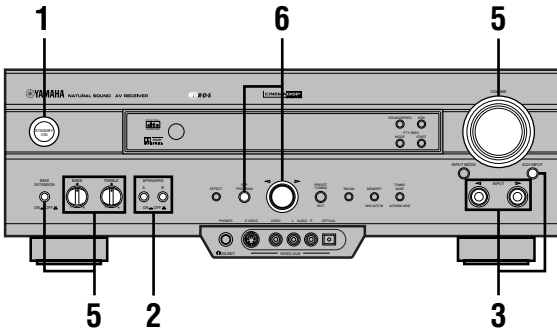

1 Press STANDBY/ON (or POWER) to turn on the power. Turn on the video monitor.

The front panel display and the video monitor show the level of the main volume for a few seconds and then switch to show the current DSP program.

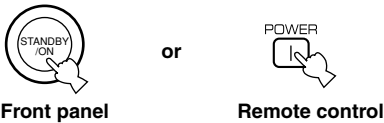

2 Press SPEAKERS A or B to select the main speakers to be used.

If you are using two sets of main speakers, press both A and B.

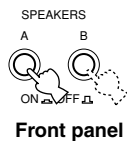

3 Press INPUT </> repeatedly (or press one of the input selector buttons) to select the input source.

- The current input source is indicated on the front panel display with a cursor.
- The current input source name and input mode appear on the front panel display and on the video monitor for a few seconds.

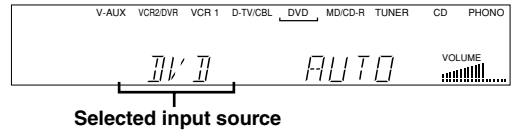
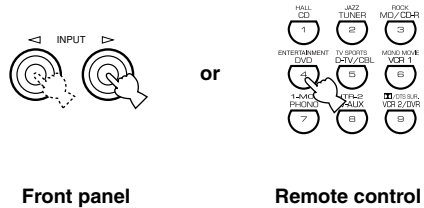

Select this:	To reproduce the signal from this component
PHONO:	Turntable
CD:	CD player
TUNER:	AM/FM tuner
MD/CD-R:	MD recorder/CD recorder/tape deck
DVD:	DVD player
D-TV/CBL:	TV/digital TV or cable TV/satellite tuner
VCR 1:	Video cassette deck 1
VCR 2/DVR:	Video cassette deck 2/digital video recorder
V-AUX:	Another audio/video component (connected to the VIDEO AUX jacks on the front panel)

To select a source connected to the 6CH INPUT jacks

Press 6CH INPUT until “6CH INPUT” appears on the front panel display and on the video monitor.

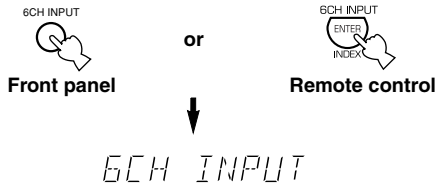

Notes

- If “6CH INPUT” is shown on the front panel display and on the video monitor, no other source can be played. To select another input source with INPUT </> (or the input selector buttons), press 6CH INPUT to turn off “6CH INPUT” from the front panel display and the video monitor.
- If you want to enjoy an audio source connected to the 6CH INPUT jacks together with a video source, first select the video source and then press 6CH INPUT.

4 Start playback (or select a broadcast station) on the source component.

Refer to the operation instructions for the component.

5 Adjust the volume to the desired output level.

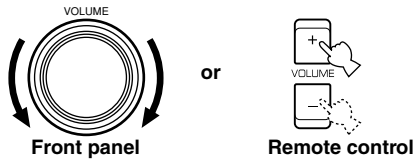

If desired, use BASS, TREBLE and BASS EXTENSION etc. These controls are only effective for sound from the main speakers.

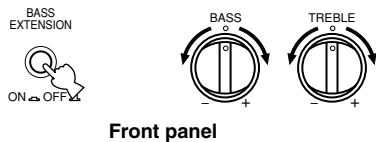

Note

- If the component connected to the VCR 1 OUT, VCR 2/DVR OUT and MD/CD-R OUT jacks is turned off, the reproduced sound may be distorted or the volume may be lowered. In these cases, turn on the component.

6 Use the digital sound field processor.

See “Selecting a Sound Field Program”.

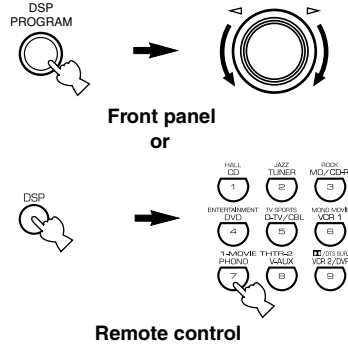

To mute the sound

Use this when you want to temporarily mute audio output.

Press MUTE on the remote control.



To restore the audio output to the previous volume level, press MUTE again.



- You can also cancel mute to press any operation buttons such as VOLUME +/-.
- During muting, “MUTE ON” appears on the front panel display and on the video monitor.

When you have finished using this unit

Press STANDBY/ON (or STANDBY) to set this unit in the standby mode.

Notes on the digital signal

The digital input jacks of this unit can also handle 96-kHz sampling digital signals. (To utilize this, use a source that supports 96-kHz sampling digital signals and set the player for digital output. Refer to the operation instructions for the player.) Note the following when a 96-kHz sampling digital signal is input to this unit:

1. The following indication will appear on the front panel display.

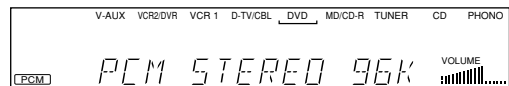

2. DSP programs cannot be selected. Sound will be output as normal 2-channel stereo sound from only the left and right main speakers.

Note

- If “1B MAIN SP” on the SET MENU is set to SMALL and “1D LFE/BASS OUT” is set to SWFR, or “1D LFE/BASS OUT” is set to BOTH, the sound is also output from the subwoofer.
3. Adjustment of the speaker output level described on page 46 cannot be made.

■ BGV (background video) function

The BGV function allows you to combine a video image from a video source with a sound from an audio source. (For example, you can listen to classical music while you are watching a video.)

Select a source from the video group and then select a source from the audio group with the input selector buttons on the remote control. The BGV function does not work if you select the sources with INPUT ◀/▶ on the front panel.

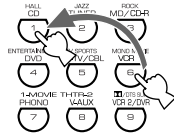

Input Modes and Indications

When using the remote control, set the selector dial to the AMP/TUN position.

This unit comes with various input jacks. If your component is connected to more than one type of input jack, you can set the priority of the input signal.

Press INPUT MODE (or the input selector button that you have pressed to select the input source on the remote control) repeatedly until the desired input mode is shown on the front panel display and on the video monitor.

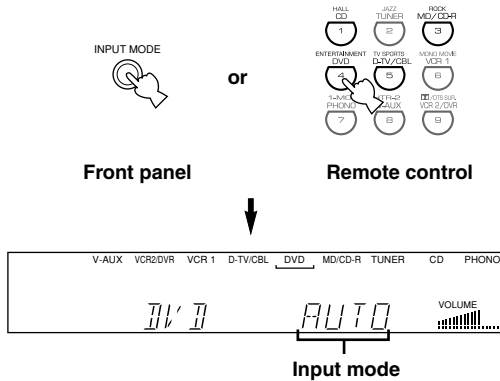

AUTO:

In this mode, the input signal is automatically selected in the following order:

- 1) Dolby Digital or DTS signal
- 2) Digital (PCM) signal
- 3) Analog signal

DTS:

In this mode, only the digital input signal encoded with DTS is selected even if another signal is input at the same time.

ANLG (ANALOG): In this mode, only the analog input signal is selected even if a digital signal is input at the same time.

Notes

- If digital signals are input from both the COAXIAL and OPTICAL jacks, the digital signal from the COAXIAL jack is selected.
- When AUTO is selected, this unit automatically determines the type of signal. If this unit detects a Dolby Digital or DTS signal, the decoder automatically switches to the appropriate setting and reproduces 5.1 channel source.
- The sound output may be interrupted for some LD players and DVD players in the following situation:
When the input mode has been set to AUTO and a search is performed while playing the source encoded with a Dolby Digital or DTS signal, the sound may delay for a moment when playback is resumed.
- Depending on the LD player, playback may not be made when playing an LD that is not digitally recorded with the input mode set to AUTO. If this happens, set the input mode to ANALOG.

■ Notes on playing a source encoded with a DTS signal

- If the digital output data of the player has been processed in any way, you may not be able to perform DTS decoding even if you make a digital connection between this unit and the player.
- If you play a source encoded with a DTS signal and set the input mode to ANALOG, this unit reproduces the noise of an unprocessed DTS signal. When you want to play a DTS source, be sure to connect the source to a digital input jack and set the input mode to AUTO or DTS.
- If you switch the input mode to ANALOG while playing a source encoded with a DTS signal, this unit reproduces no sound.
- The following phenomena may occur if the input mode is set to AUTO when playing back source encoded with a DTS signal.
 - If you continue to play a source encoded with a DTS signal, this unit automatically switches to the “DTS-decoding” mode to prevent noise from being generated during subsequent operation. (The “**dts**” indicator lights up on the front panel display.) The “**dts**” indicator may flash immediately after playback of a source encoded with a DTS signal has finished. Only a source encoded with a DTS signal can be played back while this indicator is flashing. (The indicator will flash for less than a minute.) If you want to play a normal PCM source soon, set the input mode back to AUTO.
 - The “**dts**” indicator may flash when a search or skip operation is performed. If this status continues for a certain length of time, the unit will automatically switch from the “DTS-decoding” mode to PCM digital signal input mode and the “**dts**” indicator will go out.

Selecting a Sound Field Program

You can enhance your listening experience by selecting a DSP program. For details about each program, see “SOUND FIELD PROGRAM”.

■ On the remote control

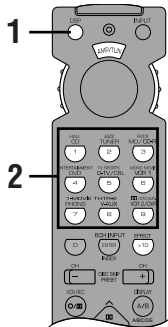

1 Press DSP.

The indicator lights up for about 3 seconds.



- If the selector dial is set to the DSP/TUN position, skip this step.

2 Use the numeric buttons to select the desired program before the indicator goes off.

- For example, to select the sub-program “SPECTACLE”, press MOVIE THEATER 1 repeatedly.
- The name of the selected program appears on the front panel display and on the video monitor.

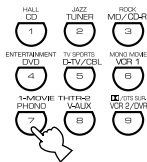

Program group

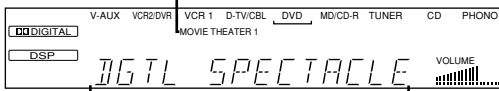

Program name (sub-program)

■ On the front panel

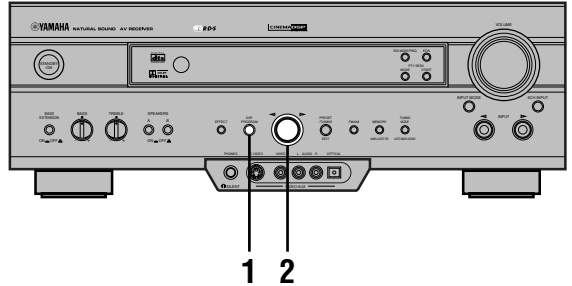

1 Press DSP PROGRAM.

DSP PROGRAM



2 Turn the multi jog knob to select the program.

The name of the selected program appears on the front panel display and on the video monitor.

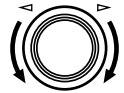

Notes

- Choose a DSP program based on your listening preference, and not on the name of the program. The acoustics of your listening room affect the DSP program. Minimize the sound reflections in your room to maximize the effect created by the program.
- When you select an input source, this unit automatically selects the last DSP program used with that source.
- When you set this unit in the standby mode, the current source and DSP program are memorized and are automatically selected when you turn on the power again.
- If a Dolby Digital or DTS signal is input when the input mode is set to AUTO, the DSP program automatically switches to the appropriate decoding program.
- When a monaural source is being played with PRO LOGIC/NORMAL or PRO LOGIC/ENHANCED, no sound will be heard from the main speakers and the rear speakers. Sound can only be heard from the center speaker. However, if “1A CENTER SP” on the SET MENU is set to NONE, the center channel sound is output from the main speakers.
- When a source connected to the 6CH INPUT jacks of this unit is selected, the digital sound field processor cannot be used.
- When 96-kHz sampling digital signals are input to this unit, the DSP program cannot be selected. In this case, the sound is reproduced as normal 2-channel stereo.

■ Virtual CINEMA DSP and SILENT CINEMA

Virtual CINEMA DSP

Virtual CINEMA DSP allows you to enjoy the sound field effects of the DSP program without rear speakers. Using YAMAHA original technology, natural surround reproduction is possible through the generation of a virtual speaker.

The sound field processing is changed to the Virtual CINEMA DSP mode by setting “1C REAR L/R SP” on the SET MENU to NONE. Virtual CINEMA DSP is performed by using the main speakers.

Note

- This unit is not set in the Virtual CINEMA DSP mode even if “1C REAR L/R SP” is set to NONE in the following cases:
 - when the 5CH STEREO, PRO LOGIC/NORMAL, DOLBY DIGITAL/NORMAL or DTS/NORMAL program is selected;
 - when the sound effect is turned off;
 - when 6CH INPUT is selected as the input source;
 - when 96-kHz sampling digital signals are input to this unit;
 - when the Dolby Digital KARAOKE source is played;
 - when using the test tone; or
 - when connecting the headphones (you will hear SILENT CINEMA).

SILENT CINEMA

SILENT CINEMA allows you to enjoy the realistic feel of the DSP program while using headphones. This feature delivers powerful surround reproduction just as if listening through the speakers.

You can listen to SILENT CINEMA by connecting your headphones to the PHONES jack while the effect speakers are on.

Normal Stereo Reproduction

Press EFFECT to turn off the sound effect for normal stereo reproduction.

Press EFFECT again to turn the sound effect back on.

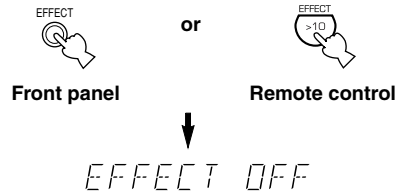

- If the selector dial is set to a position other than the DSP/TUN position, first press DSP and then EFFECT on the remote control.

Notes

- If you turn off the sound effect, no sound is output from the center and rear speakers.
- If you turn off the sound effect while a Dolby Digital or DTS signal is being output, the dynamic range of the signal is automatically compressed and the sounds of the center and rear speaker channels are mixed and output from the main speakers.
- The volume may be greatly reduced when you turn off the sound effect or if you set “6 D-RANGE” on the SET MENU to MIN. In this case turn on the sound effect.

TUNING

Connecting the Antennas

Both AM and FM indoor antennas are included with this unit. In general, these antennas should provide sufficient signal strength.

Connect each antenna correctly to the designated terminals.

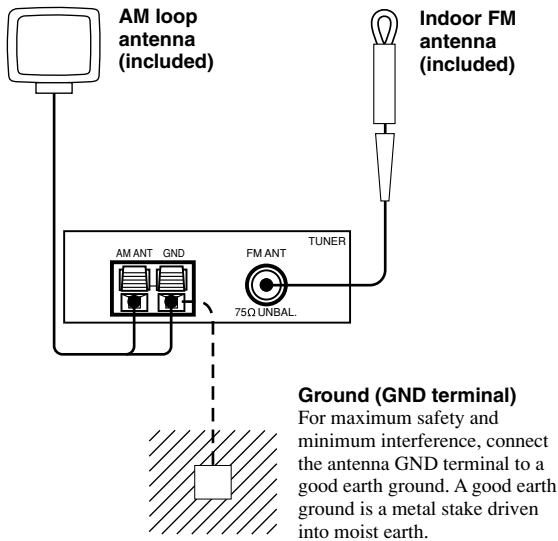

■ Connecting the indoor FM antenna

Connect the included indoor FM antenna to the FM ANT 75Ω UNBAL. terminal.

Note

- Do not connect an outdoor FM antenna and the indoor FM antenna at the same time.

■ Connecting the AM loop antenna

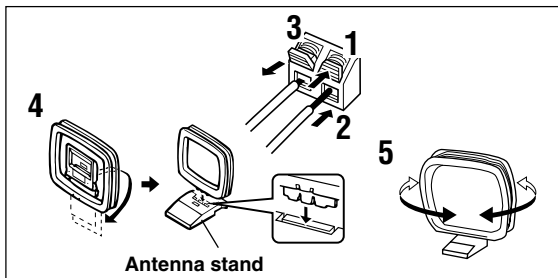

1 Press and hold the tab to unlock the terminal hole.

2 Insert the AM loop antenna lead wires into the AM ANT and GND terminals.

3 Release the tab to lock the lead wires.
Lightly pull the lead wires to confirm a good connection.

4 Attach the loop antenna to the antenna stand.

5 Orient the AM loop antenna so that the best reception is obtained.



- The AM loop antenna can be removed from the stand and attached to a wall, etc.

Notes

- The AM antenna should be placed away from this unit.
- The AM loop antenna should always be connected, even if an outdoor AM antenna is connected to this unit.

A properly installed outdoor antenna provides clearer reception than an indoor one. If you experience poor reception quality, an outdoor antenna may improve the quality. Consult the nearest authorized YAMAHA dealer or service center about the outdoor antennas.

Connecting a coaxial cable to the included 75-ohm/300-ohm antenna adapter (U.K. model only)

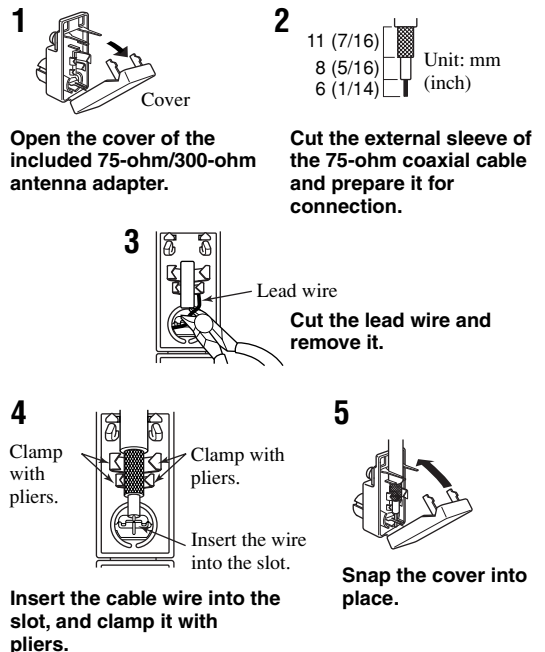

Automatic (or Manual) Tuning

Automatic tuning is effective when station signals are strong and there is no interference.

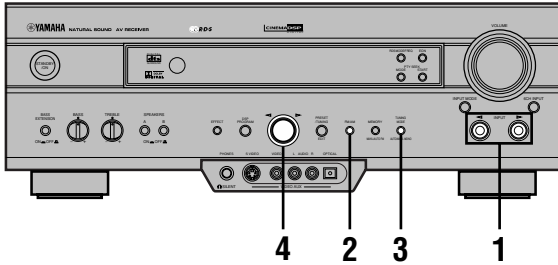

1 Press INPUT $\triangleleft/\triangleright$ to select TUNER as the input source.

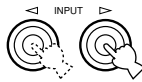

2 Press FM/AM to select the reception band. "FM" or "AM" appears on the front panel display.

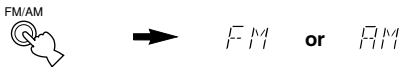

3 Press TUNING MODE (AUTO/MAN'L MONO) so that the "AUTO" indicator lights up on the front panel display.

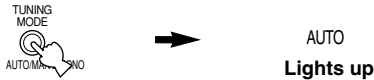

If ">" appears on the front panel display next to the band indication, press PRESET/TUNING (EDIT) to turn it off.

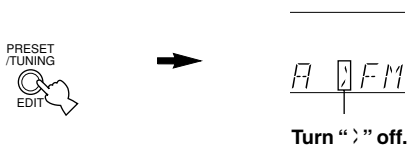

4 Turn the multi jog knob to the right or left to begin automatic tuning.

Turn the multi jog knob to the right for tuning in to a higher frequency, or to the left for tuning in to a lower frequency. Turn the knob again if the tuning search does not stop at the desired station.



- Use the manual tuning method if the tuning search does not stop at the desired station because the signal is weak.
- When tuned in to a station, the "TUNED" indicator lights up and the frequency of the received station is shown on the front panel display. If an RDS station that offers the PS data service is being received, the station name is shown instead of the frequency on the front panel display.

If the signal from the station you want to select is weak, you must tune in to it manually.

1 Press INPUT $\triangleleft/\triangleright$ to select TUNER as the input source.

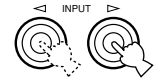

2 Press FM/AM to select the reception band. "FM" or "AM" appears on the front panel display.

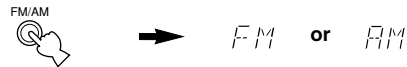

3 Press TUNING MODE (AUTO/MAN'L MONO) so that the "AUTO" indicator goes off from the front panel display.



If ">" appears on the front panel display next to the band indication, press PRESET/TUNING (EDIT) to turn it off.

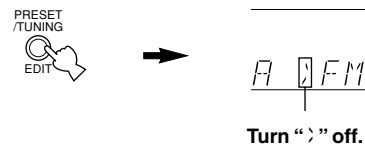

4 Turn the multi jog knob to the right or left to tune in to the desired station manually.

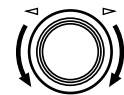

Note

- Manually tuning in to an FM station will automatically change the reception mode to monaural to increase the signal quality.

Presetting Stations

■ Automatically presetting stations (for RDS stations)

You can use the automatic preset tuning feature to store RDS stations. This function enables the unit to automatically tune in to RDS stations with strong signals, and to store up to 40 (8 stations x 5 groups) of those stations in order. This feature enables you to easily tune in to any preset station by selecting the preset station number (see “Tuning in to a Preset Station”).

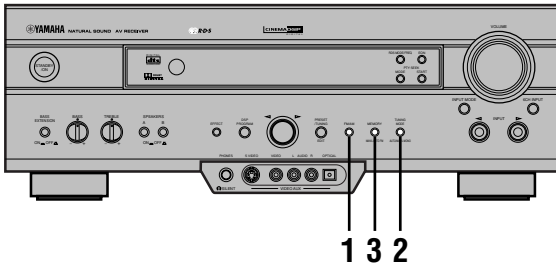

1 Press FM/AM to select the FM band.



2 Press TUNING MODE (AUTO/MAN'L MONO) so that the “AUTO” indicator lights up on the front panel display.



3 Press and hold MEMORY (MAN'L/AUTO FM) for more than 3 seconds.

The preset number, the “MEMORY” and “AUTO” indicators flash. Then, after about 5 seconds, automatic preset tuning begins from the frequency currently displayed toward the higher frequencies.

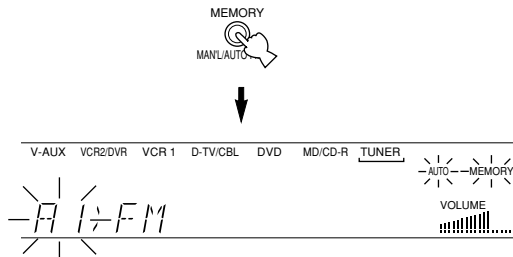

When automatic preset tuning is completed, the front panel display shows the frequency of the last preset station.

Notes

- Any stored station data existing under a preset number is cleared when you store a new station under that preset number.
- The reception mode is stored along with the station frequency.
- You can manually replace a preset station with another FM or AM station by simply following the procedure in the section “Manually presetting stations”.
- If the number of the received stations does not reach E8, automatic preset tuning has automatically stopped after searching all stations.
- Only RDS stations with sufficient signal strength are stored automatically by automatic preset tuning. If the station you want to store is weak in signal strength, tune in to it manually in the monaural mode, and store it by following the procedure in “Manually presetting stations”. (There may be a case that this unit cannot receive a station which could be received by using the automatic tuning method. This is because this unit receives a large amount of PI (Program Identification) data along with the station.)

Automatic preset tuning options

You can select the preset number from which the unit will store RDS stations and/or begin tuning toward lower frequencies. Before automatic preset tuning begins (after pressing MEMORY in step 3):

1. Turn the multi jog knob to select the preset number under which the first station will be stored.
Automatic preset tuning will stop when stations have all been stored up to E8.
2. Press PRESET/TUNING (EDIT) to turn off “>” and then turn the multi jog knob to the left to begin tuning toward lower frequencies.

Memory back-up

The memory back-up circuit prevents the stored data from being lost even if this unit is set in the standby mode, the power cord is disconnected from the AC outlet, or the power supply is temporarily cut due to power failure. However, if the power is cut for more than one week, the preset stations may be cleared. If so, store the stations again by using the presetting station methods.

Manually presetting stations

You can also store up to 40 stations (8 stations x 5 groups) manually.

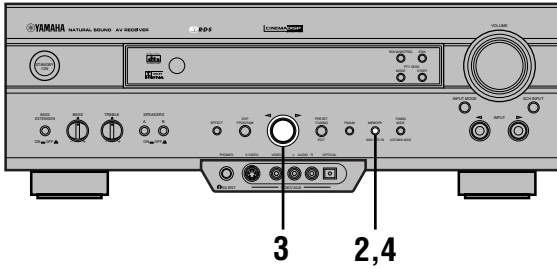

1 Tune in to a station.

See “Automatic (or Manual) Tuning” for tuning instructions.

2 Press MEMORY (MAN'L/AUTO FM).

The “MEMORY” indicator flashes for about 5 seconds.

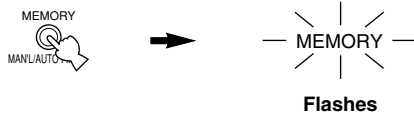

3 Turn the multi jog knob to select a preset station number while the “MEMORY” indicator is flashing.

Turn the multi jog knob to the right to select a higher preset station number, and to the left to select a lower preset station number.

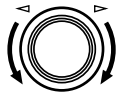

4 Press MEMORY (MAN'L/AUTO FM) while the “MEMORY” indicator is flashing.

The station band and frequency appear on the front panel display with the preset group and number you have selected.

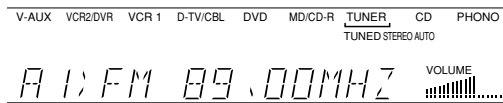

Shows the displayed station has been stored as A1.

5 Repeat steps 1 to 4 to store other stations.

Notes

- Any stored station data existing under a preset number is cleared when you store a new station under that preset number.
- The reception mode is stored along with the station frequency.

Tuning in to a Preset Station

You can tune any desired station simply by selecting the preset station number under which it was stored.

On the remote control

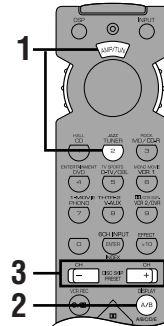

1 Set the selector dial to the AMP/TUN position and press TUNER to select TUNER as the input source.



2 Press A/B/C/D/E to select the preset station group.

The preset group letter appears on the front panel display and changes each time you press A/B/C/D/E.



3 Press PRESET +/- to select a preset station number (1 to 8).

The preset group and number appear on the front panel display along with the station band, frequency and the “TUNED” indicator lights up.

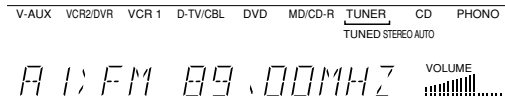
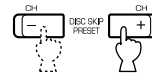

- You can select the preset station number with the numeric buttons (1 to 8) if code number “0023” has been set up in the AMP/TUN (or DSP/TUN) position.

■ On the front panel

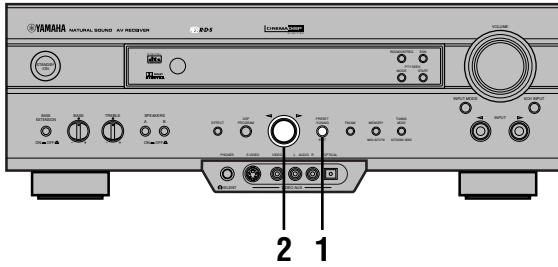

1 Press PRESET/TUNING (EDIT) so that “>” next to the band indicator appears.



2 Turn the multi jog knob to select the desired preset station number.

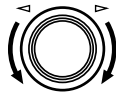

The preset group and number appear on the front panel display along with the station band, frequency, and the “TUNED” indicator lights up.

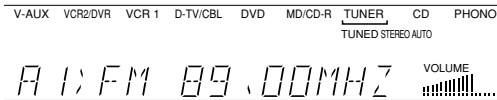

Exchanging Preset Stations

You can exchange the assignment of two preset stations with each other. The example below describes the procedure for exchanging preset station “E1” with “A5”.

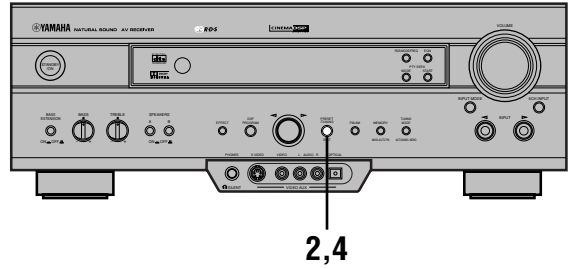

1 Tune in to preset station “E1”.

See “Tuning in to a Preset Station”.

2 Press and hold PRESET/TUNING (EDIT) for more than 3 seconds.

“E1” and the “MEMORY” indicator flash on the front panel display.

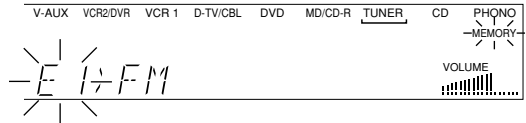

3 Tune in to preset station “A5” by using the buttons on the front panel.

“A5” and the “MEMORY” indicator flash on the front panel display.

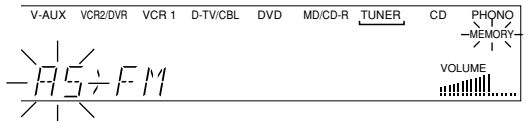

4 Press PRESET/TUNING (EDIT) again.

The stations stored at the two preset assignments are exchanged.

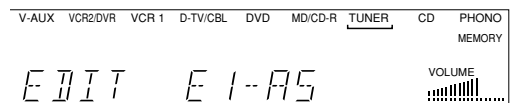

Shows the exchange of stations has been completed.

RECEIVING RDS STATIONS

RDS (Radio Data System) is a data transmission system by FM stations in many countries. Stations using this system transmit an inaudible stream of data in addition to the normal radio signal.

RDS data contains various information such as PI (Program Identification), PS (Program Service name), PTY (Program Type), RT (Radio Text), CT (Clock Time), EON (Enhanced Other Networks), etc. The RDS function is carried out among the network stations.

Description of RDS Data

This unit can receive PI, PS, PTY, RT, CT, and EON data when receiving RDS broadcasting stations.

■ PS (Program Service name) mode:

The name of the RDS station being received is displayed.

■ PTY (Program Type) mode:

The program type on the RDS station being received is displayed. There are 15 program types to classify RDS stations. You can make this unit search for a station which is broadcasting a program of the desired type. See “PTY SEEK Function” for details.

■ RT (Radio Text) mode:

Information about the program (such as the title of the song, name of the singer, etc.) on the RDS station being received is displayed by a maximum of 64 alphanumeric characters, including the umlaut symbol. If other characters are used for RT data, they are displayed with under-bars.

■ CT (Clock Time) mode:

The current time is displayed and updated every minute. If the data are accidentally cut off, “CT WAIT” may appear.

■ EON (Enhanced Other Networks):

See “EON Function”.

Changing the RDS Mode

The four modes are available in this unit for displaying RDS data. When an RDS station is being received, PS, PTY, RT and/or CT mode indicators that correspond to the RDS data services offered by the station light up on the front panel display. Press RDS MODE/FREQ repeatedly to change the display mode among the RDS data offered by the transmitting station in the order shown below. Illumination of the red indicator next to the RDS mode indicator shows that the corresponding RDS mode is now selected.

Notes

- When an RDS station is being received, do not press RDS MODE/FREQ until one or more RDS mode indicators light up on the front panel display. If you press the button before the indicators light up on the front panel display, the mode cannot be changed. This is because the unit has not yet received all of the RDS data on the station.
- RDS data not offered by the station cannot be selected.
- The RDS data service cannot be utilized by this unit if the received signal is not strong enough. In particular, the RT mode requires a large amount of data to be received, so it is possible that the RT mode may not be displayed even if other RDS modes (PS, PTY, etc.) are displayed.
- RDS data cannot sometimes be received under poor reception conditions. If so, press TUNING MODE so that the “AUTO” indicator goes off from the front panel display. Although the reception mode is changed to monaural by this operation, when you change the display to RDS mode, RDS data may be displayed.
- If the signal strength is weakened by external interference during the reception of an RDS station, the RDS data service may be cut off suddenly and “...WAIT” will appear on the front panel display.

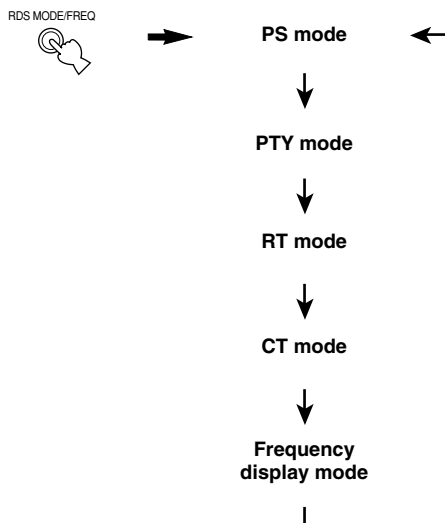

PTY SEEK Function

If you select the desired program type, the unit automatically searches all preset RDS stations that are broadcasting a program of the required type.

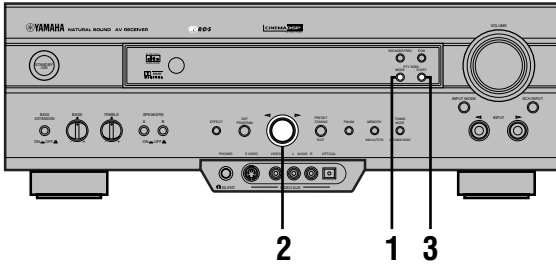

1 Press PTY SEEK MODE to set the unit in the PTY SEEK mode.

The program type of the station being received or “NEWS” flashes on the front panel display.



2 Turn the multi jog knob to select the desired program type.

The selected program type appears on the front panel display.



3 Press PTY SEEK START to begin searching all preset RDS stations.

The selected program type flashes and the “PTY HOLD” indicator lights up on the front panel display while searching for stations.

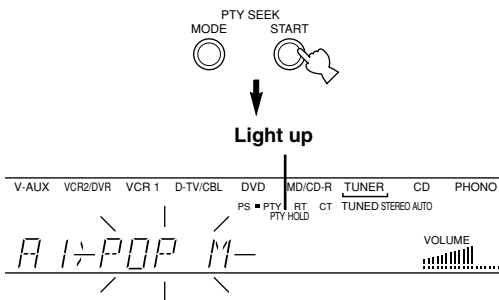

The selected program type flashes.

- If a station that is broadcasting a program of the required type is found, the unit stops at that station.
- If the called station is not the desired one, press PTY SEEK START again. The unit begins searching for another station that is broadcasting a program of the same type.

To cancel this function

Press PTY SEEK MODE twice.

Program types in the PTY mode

There are 15 program types to classify RDS stations.

NEWS	News
AFFAIRS	Current affairs
INFO	General information
SPORT	Sports
EDUCATE	Education
DRAMA	Drama
CULTURE	Culture
SCIENCE	Science
VARIED	Light entertainment
POP M	Pops
ROCK M	Rock
M.O.R. M	Middle-of-the-road music (easy-listening)
LIGHT M	Light classics
CLASSICS	Serious classics
OTHER M	Other music

EON Function

This function uses the EON data service on the RDS station network. If you simply select the desired program type (NEWS, INFO, AFFAIRS or SPORT), the unit automatically searches for all preset RDS stations that are scheduled to broadcast a program of the required type and switches from the station being currently received to the new station when the broadcasts starts.

Note

- This function can only be used when an RDS station that offers the EON data service is being received. When such a station is being received, the “EON” indicator lights up on the front panel display.

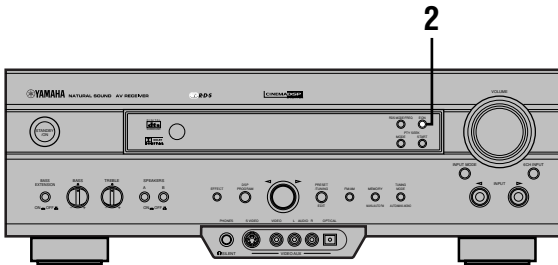

1 Make sure that the “EON” indicator lights up on the front panel display.

If the “EON” indicator does not light up, tune in to another RDS station so that the “EON” indicator lights up.

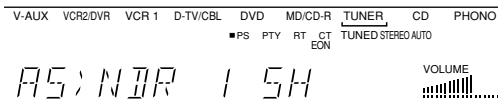

2 Press EON repeatedly to select the desired program type (NEWS, INFO, AFFAIRS or SPORT).

The selected program type name indicator lights up on the front panel display.

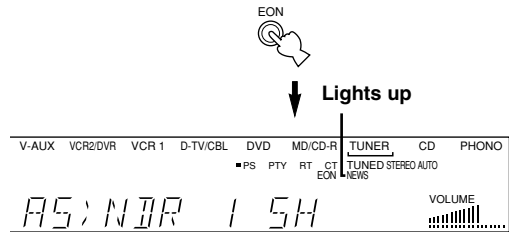

- If a preset RDS station of the selected program type starts broadcasting, the unit will automatically switch from the program being currently received to that program. The program type name indicator flashes.

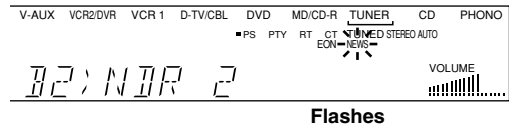

- When broadcasting of the required program ends, the previously received station (or another program on the same station) is recalled.

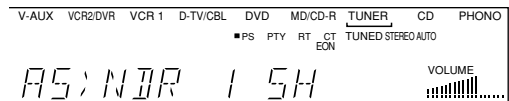

■ To cancel this function

Press EON repeatedly until no program type name lights up on the front panel display.

BASIC RECORDING

Recording adjustments and other operations are performed from the recording components. Refer to the operation instructions for these components.

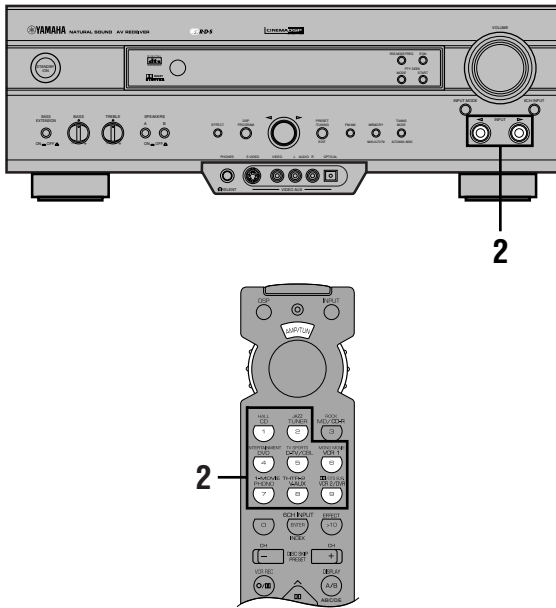

1 Turn on the power to the unit and all connected component.

2 Select the source component you want to record from.

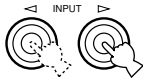

Front panel

or

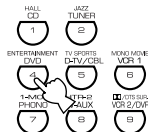

Remote control

3 Start playback (or select a broadcast station) on the source component.

4 Start recording on the recording component.

Notes

- Do a test recording before you start an actual recording.
- When this unit is set in the standby mode, you cannot record between other components connected to this unit.
- The setting of BASS, TREBLE, BASS EXTENSION, VOLUME, "2 L/R BALANCE" on the SET MENU and DSP programs does not affect the recorded material.
- A source connected to the 6CH INPUT jacks of this unit cannot be recorded.
- S-video and composite video signals pass independently through this unit's video circuits. Therefore, when recording or dubbing video signals, if your video source component is connected to provide only an S-video (or only a composite video) signal, you can record only an S-video (or only a composite video) signal by your VCR.
- A given input source is not output on the same REC OUT channel. (For example, the signal input from VCR 1 IN is not output on VCR 1 OUT.)
- Check the copyright laws in your country to record from records, CDs, radio, etc. Recording of copyrighted material may infringe copyright laws.

If you playback a video source that uses scrambled or encoded signals to prevent it from being dubbed, the picture itself may be disturbed due to those signals.

Special considerations when recording DTS software

The DTS signal is a digital bitstream. Attempting to digitally record the DTS bitstream will result in noise being recorded. Therefore, if you want to use this unit to record sources that have DTS signals recorded on them, the following considerations and adjustments need to be made.

For DVDs and CDs encoded with DTS

Only 2-channel analog audio signals may be recorded. Set the DVD player (or CD player) as described in the player's operation instructions so that the audio signals are output from the player's analog outputs.

SET MENU

The SET MENU consists of 10 items including the speaker mode setting features. Use the SET MENU to enjoy the optimum audio/video playback for your system.



- You can adjust the items on the SET MENU while playing a source.
- We recommend that you adjust the items on the SET MENU while using a video monitor. It is easier to see the video monitor than it is to see the front panel display on this unit while adjusting the items.

Note

- The indication on the front panel display is the abbreviation of the OSD.

1 SPEAKER SET

- 1A CENTER SP
- 1B MAIN SP
- 1C REAR L/R SP
- 1D LFE/BASS OUT
- 1E MAIN LEVEL

2 L/R BALANCE

3 HP TONE CTRL

4 I/O ASSIGNMENT

- 4A CMPNT-V INPUT
- 4B OPTICAL OUT
- 4C OPTICAL IN
- 4D COAXIAL IN

5 INPUT MODE

6 DOLBY D. SET

- LFE LEVEL
- D-RANGE

7 DTS SET

8 SP DELAY TIME

9 DISPLAY SET

- BLUE BACK
- OSD SHIFT
- DIMMER

10 MEMORY GUARD

Adjusting the Items on the SET MENU

Adjustment should be made with the remote control.

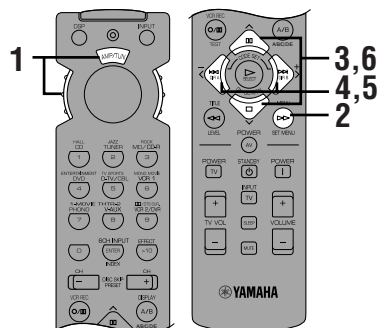

Note

- Some items require extra steps to change to the desired setting.

1 Set the selector dial to the AMP/TUN (or DSP/TUN) position.



2 Press SET MENU to enter the SET MENU.



SET MENU 1/3

- 1 SPEAKER SET
- 2 L/R BALANCE
- 3 HP TONE CTRL
- 4 I/O ASSIGNMENT
- ▲/▼ : Up/Down
- /+ : Enter

3 Press repeatedly to select the item (1 to 10) you want to adjust.

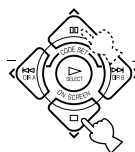

SET MENU 1/3

- 1 SPEAKER SET
- 2 L/R BALANCE
- 3 HP TONE CTRL
- 4 I/O ASSIGNMENT
- ▲/▼ : Up/Down
- /+ : Enter



- By pressing SET MENU repeatedly, you can select items in the same order as when pressing .

4 Press < or > once to enter the setup mode of the selected item.

The last setting you adjusted appears on the video monitor or on the front panel display.

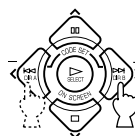

4A CMPNT-V INPUT

- [A] DVD
- [B] D-TV/CBL

Depending on the item, press \wedge/\vee to select a sub item.

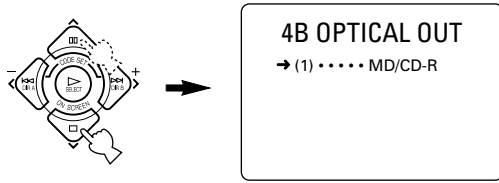

5 Press \langle / \rangle repeatedly to change the setting of the item.

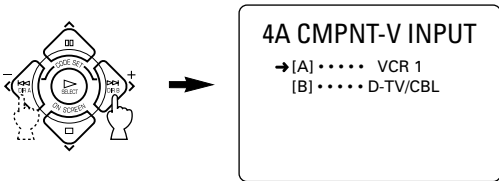

6 Press \wedge/\vee repeatedly until the current DSP program appears or simply press one of the DSP program group button to exit from the SET MENU.

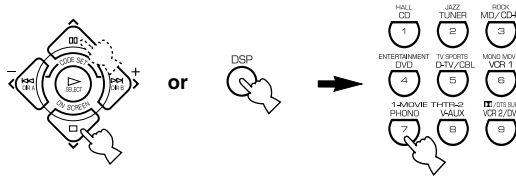

Memory back-up
The memory back-up circuit prevents the stored data from being lost even if this unit is set in the standby mode, the power cord is disconnected from the AC outlet, or the power supply is temporarily cut due to power failure. However, if the power is cut for more than one week, the settings of the SET MENU you adjusted will return to the factory settings. If so, adjust the items again.

1 SPEAKER SET (speaker mode settings)

Use this feature to select suitable output modes for your speaker configuration.

Notes

- When 96-kHz sampling digital signals are input to this unit, level adjustments in items 1B and 1D are possible, but those in items 1A, 1C and 1E are not affected.
- When 6CH INPUT is selected as the input source, level adjustments in items 1A through 1E are not affected.

1A CENTER SP (center speaker mode)

By adding a center speaker to your speaker configuration, the unit can provide good dialog localization for many listeners and superior synchronization of sound and images. The OSD shows a large, small or no center speaker depending on how you set this item.

Choices: LRG (large), SML (small), NONE
Initial setting: LRG

LRG

Select this if you have a large center speaker. The entire range of the center channel signal is directed to the center speaker.

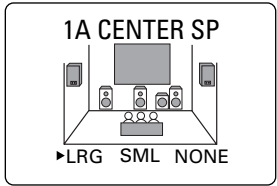

SML

Select this if you have a small center speaker. The low-frequency signals (90 Hz and below) of the center channel are directed to the speakers selected with "1D LFE/BASS OUT".

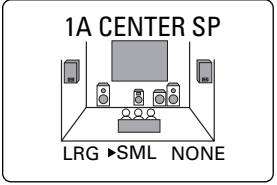

NONE

Select this if you do not have a center speaker. All of the center channel signals are directed to the left and right main speakers.

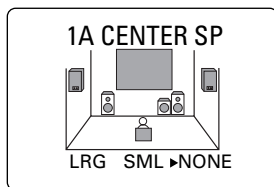
**1B MAIN SP (main speaker mode)**

The OSD shows large or small main speakers depending on how you set this item.

Choices: LARGE, SMALL

Initial setting: LARGE

LARGE

Select this if you have large main speakers. The entire range of the left and right main channel signal is directed to the left and right main speakers.

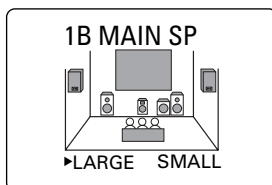
**SMALL**

Select this if you have small main speakers. The low-frequency signals (90 Hz and below) of the main channel are directed to the speakers selected with "1D LFE/BASS OUT".

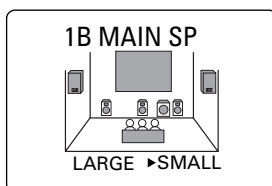
**Note**

- When you select MAIN for "1D LFE/BASS OUT", the low-frequency signals (90 Hz and below) of the main channel are directed to the main speakers even if you select SMALL for the main speaker mode.

1C REAR L/R SP (rear speaker mode)

The OSD shows large, small or no rear speakers depending on how you set this item.

Choices: LRG (large), SML (small), NONE

Initial setting: LRG

LRG

Select this if you have large left and right rear speakers or if a rear subwoofer is connected to the rear speakers. The entire range of the rear channel signal is directed to the left and right rear speakers.

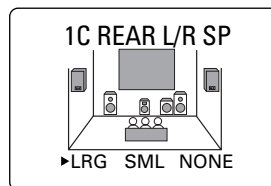
**SML**

Select this if you have small left and right rear speakers. The low-frequency signals (90 Hz and below) of the rear channel are directed to the speakers selected with "1D LFE/BASS OUT".

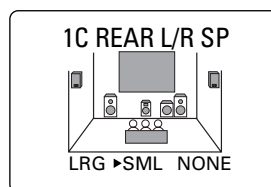
**NONE**

Select this if you do not have rear speakers.

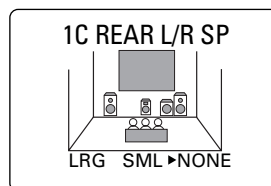

- This unit is set in the Virtual CINEMA DSP mode by selecting NONE for "1C REAR L/R SP".

■ 1D LFE/BASS OUT (bass out mode)

LFE signals carry low-frequency effects when this unit decodes a Dolby Digital or DTS signal. Low-frequency signals are defined as 90 Hz and below.

Choices: SWFR (subwoofer), MAIN, BOTH
Initial setting: BOTH

SWFR

Select this if you use a subwoofer. The LFE signals are directed to the subwoofer.

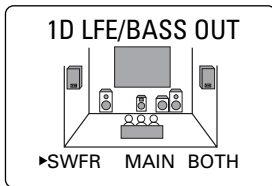

MAIN

Select this if you do not use a subwoofer. The LFE signals are directed to the main speakers.

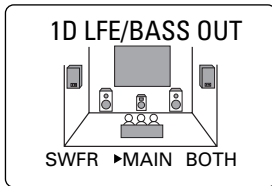

BOTH

Select this if you use a subwoofer and you want to mix the main channel low-frequency signals with the LFE signals.

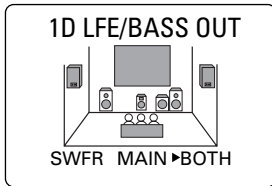

Notes

- When playing a 2-channel source (CD, MD, tape, video cassette etc.), select the BOTH position to direct low bass signals (below 90 Hz) to the SUBWOOFER jack.
- When you select SMALL (SML) for items 1A, 1B and 1C, the low-frequency signals (90 Hz and below) from those channels are added to the LFE and output to the subwoofer.

■ 1E MAIN LEVEL (main level mode)

Change this setting if you cannot match the output level of the center and rear speakers with the main speakers because of the unusually high-efficiency performance of the main speakers.

Choices: Normal, -10 dB
Initial setting: Normal

Normal

Normally select this setting.

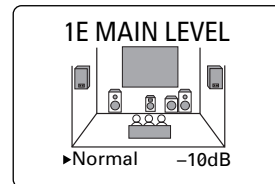

-10 dB

Select this if you cannot match the output level of your effect speakers with that of your main speakers when using the test tone. This setting decreases the main speaker output level to about one-third of the normal level.

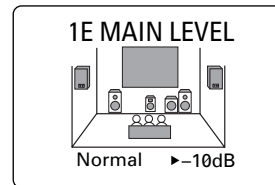

2 L/R BALANCE (balance of the left and right main speakers)

Use this feature to adjust the balance of the output level from the left and right main speakers.

Control range: 10 for L/R
Initial setting: 0

Press > to decrease the output level for the left main speaker. Press < for the right main speaker.

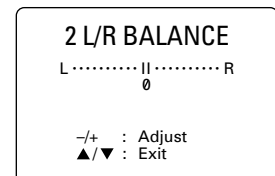

Note

- The L/R BALANCE setting also applies to when headphones are being used.

3 HP TONE CTRL (headphone tone control)

Use this feature to adjust the level of the bass and treble when you use your headphones.

Control range (dB): -6 to +3

Initial setting: 0 dB for both BASS and TRBL (treble)

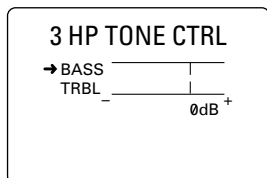

4 I/O ASSIGNMENT

It is possible to assign jacks according to the component to be used if this unit's COMPONENT VIDEO input jack or DIGITAL INPUT/OUTPUT jack settings (component names for jacks) differ from that component. This makes it possible to change the jack assignment and effectively connect more component.

Once you assign, you can select that component with INPUT ◀/▶ (or the input selector buttons).

4A CMPNT-V INPUT (for the COMPONENT VIDEO jacks)

Initial settings: [A] DVD

[B] D-TV/CBL

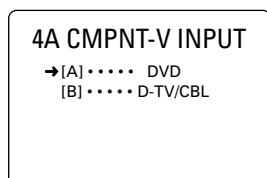

4B OPTICAL OUT (for the OPTICAL OUTPUT jack)

Initial setting: (1) MD/CD-R

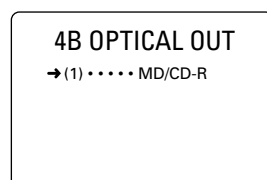

4C OPTICAL IN (for the OPTICAL INPUT jacks)

Initial settings: (2) MD/CD-R

(3) DVD

(4) D-TV/CBL

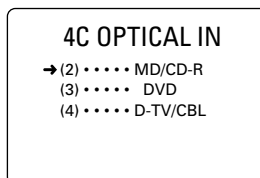

4D COAXIAL IN (for the COAXIAL INPUT jack)

Initial setting: (5) CD

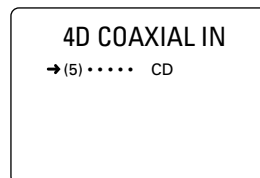

Note

- You cannot select an item more than once for the same type of jack.

5 INPUT MODE (initial input mode)

Use this feature to designate the input mode when turning on the power of this unit with the source component connected to more than one type of input jacks.

Choices: AUTO, LAST

Initial setting: AUTO

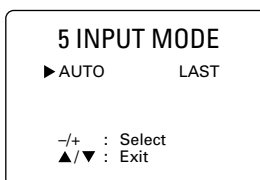

AUTO

Select this to allow this unit to automatically detect the type of input signal and select the appropriate input mode.

LAST

Select this to set this unit to automatically select the last input mode used for that source.

6 DOLBY D. SET (Dolby Digital set)

This setting is effective only when this unit decodes Dolby Digital signals.

6 DOLBY D. SET

→ LFE LEVEL 0dB
 D-RANGE
 . . . ▶ MAX STD MIN
 +/- : Adjust
 ▲/▼ : Select

■ LFE LEVEL

Use this feature to adjust the output level of the LFE (low-frequency effect) channel when playing back a Dolby Digital signal. The LFE signal carries the low-frequency special effect sound which is only added to certain scenes.

Control value (dB): -20 to 0

Initial setting: 0 dB

Notes

- Adjust the LFE level according to the capacity of your subwoofer.
- Normally, around -6 dB to -8 dB is most suitable for listening at home.

■ D-RANGE (dynamic range)

Use this feature to adjust the dynamic range (the difference between the maximum level and the minimum level of sounds).

Choices: MAX, STD (standard), MIN

Initial setting: MAX

- Select MAX for feature films.
- Select STD for general use.
- Select MIN for listening to sources at an extremely low volume level.

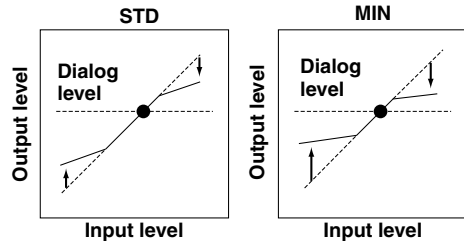
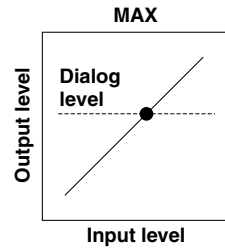

Note

- When you select MIN, the sound output may be faint because some Dolby Digital signals are not compatible with the minimum-level dynamic range. In this case, select MAX or STD.

7 DTS SET (DTS LFE level)

This setting is effective only when this unit decodes DTS signals.

Use this feature to adjust the output level of the LFE (low-frequency effect) channel when playing back a DTS signal. The LFE signal carries the low-frequency special effect sound which is only added to certain scenes.

Control range (dB): -10 to +10

Initial setting: 0 dB

7 DTS SET

LFE LEVEL 0dB

-/+ : Adjust
 ▲/▼ : Exit

Note

- Adjust the LFE level according to the capacity of your subwoofer.

8 SP DELAY TIME

Use this feature to adjust the delay of the center channel sound. This feature works when this unit decodes a Dolby Digital or DTS signal. Ideally, the center speaker should be the same distance from the listening position as the left and right main speakers. However, in most home situations, the center speaker is placed in line with the main speakers. By delaying the sound from the center speaker, the apparent distance from the center speaker to the listening position can be adjusted to make it seem the same as the distance between the left and right main speakers to the listening position. Adjusting the delay time for the center speaker is especially important for giving depth to the dialog.

Control range (ms): 0 to 5

Initial setting: 0 ms

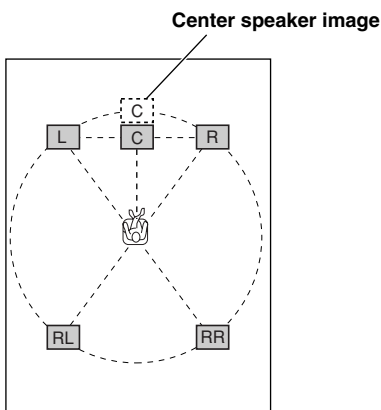
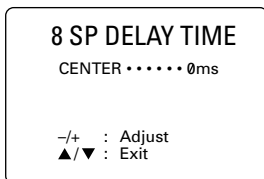

- Increasing the delay by 1 ms simulates moving the speaker about 30 cm (one foot) farther away from the actual position of the center speaker.

9 DISPLAY SET

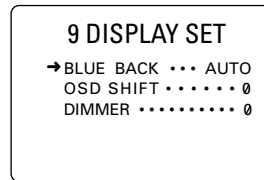

■ BLUE BACK

Selecting AUTO for the on-screen display setting displays a blue background when there's no video signal input. Nothing is displayed on the screen including the on-screen display if OFF is selected.

Initial setting: AUTO

■ OSD SHIFT (OSD off-set position)

This setting is used to adjust the vertical position of the OSD.

Control range: +5 (downward) to -5 (upward)

Initial setting: 0

Press > to lower the position of the OSD.

Press < to raise the position of the OSD.

■ DIMMER

You can adjust the brightness of the front panel display.

Control range: -4 to 0

Initial setting: 0

10 MEMORY GUARD

Use this feature to prevent accidental changes to DSP program parameter values and other settings on this unit.

Choices: ON, OFF

Initial setting: OFF



Select ON to protect the following features:

- DSP program parameters
- All SET MENU items
- Center, rear speakers and subwoofer levels
- The on-screen display (OSD) mode

Notes

- When "10 MEMORY GUARD" is set to ON, you cannot use the test tone.
- When "10 MEMORY GUARD" is set to ON, you cannot select any other SET MENU items.

ADJUSTING THE LEVEL OF THE EFFECT SPEAKERS

You can adjust the output level of each effect speaker (center, left and right rear and subwoofer) while listening to a music source.

Adjustment should be made with the remote control.

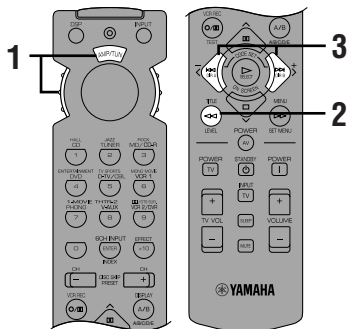

3 Press </> to adjust the speaker output level.

- The control range for the center or left and right rear speakers is from +10 dB to -10 dB.
- The control range for the subwoofer is from 0 dB to -20 dB.

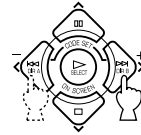

Notes

- If the speaker output mode is set to NONE, the output level of that speaker cannot be adjusted.
- When you adjust the output level with LEVEL, the settings you made with the test tone will be changed.
- To adjust speakers other than the subwoofer, the adjusting procedure using the test tone on page 22 is recommended.

1 Set the selector dial to the AMP/TUN (or DSP/TUN) position.



2 Press LEVEL repeatedly to select the speaker(s) you want to adjust.

Each time you press LEVEL, the selected speaker changes and appears on the front panel display and on the video monitor as follows: center, right rear, left rear and subwoofer.

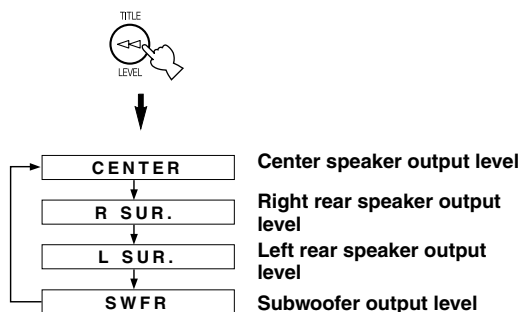

- Once you press LEVEL, you can also select the speaker(s) to be adjusted by pressing ∨. (Pressing ∧ changes the selection in the reverse order.)

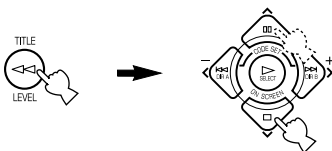

Memory back-up

The memory back-up circuit prevents the stored data from being lost even if this unit is set in the standby mode, the power cord is disconnected from the AC outlet, or the power supply is temporarily cut due to power failure. However, if the power is cut for more than one week, the output level of the effect speakers you adjusted will return to the factory settings. If so, adjust the output level again.

SLEEP TIMER

Use this feature to automatically set this unit in the standby mode after the amount of time you have set. The sleep timer is useful when you are going to sleep while this unit is playing or recording a source. The sleep timer also automatically turns off the external components connected to AC OUTLET(S).

The sleep timer can only be set with the remote control.

Setting the Sleep Timer

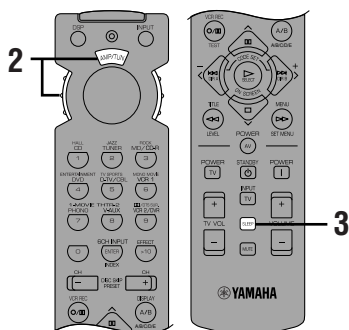

1 Select a source and start playback on the source component.

2 Set the selector dial to a position other than the TV position.



3 Press SLEEP repeatedly to set the amount of time before this unit automatically turns off.



Each time you press SLEEP, the front panel display changes as shown below.

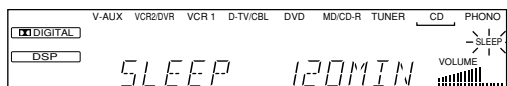
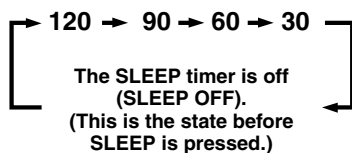

4 The "SLEEP" indicator soon lights up on the front panel display after the sleep timer has been set.

The display then returns to the previous indication.

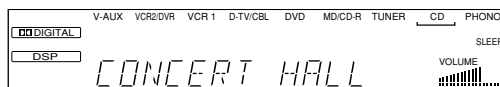

Canceling the Sleep Timer

Press SLEEP repeatedly until "SLEEP OFF" appears on the front panel display.

After a few seconds, "SLEEP OFF" disappears, the "SLEEP" indicator goes off and the display returns to the previous indication.

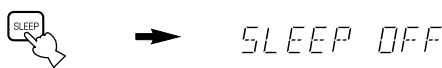

- The sleep timer setting can also be canceled by setting this unit in the standby mode by using STANDBY on the remote control (or STANDBY/ON on the front panel) or by disconnecting the AC power cord from the AC outlet.

REMOTE CONTROL FEATURES

It is possible to control this unit and other YAMAHA A/V components using the remote control supplied with this unit. It is also possible to control components from other manufacturers (or some YAMAHA components) by setting the proper manufacturer code (a signal assigned to each manufacturer and component).

Note

- For the notes on batteries, operating distance and names and functions of the remote control, refer to each description in this manual.

Selector Dial

Select the component (position) to be controlled by the remote control. For example, if the CD position is selected, the remote control is set in the CD operation mode, allowing the CD player to be controlled. When turning the selector dial, the position changes as follows:

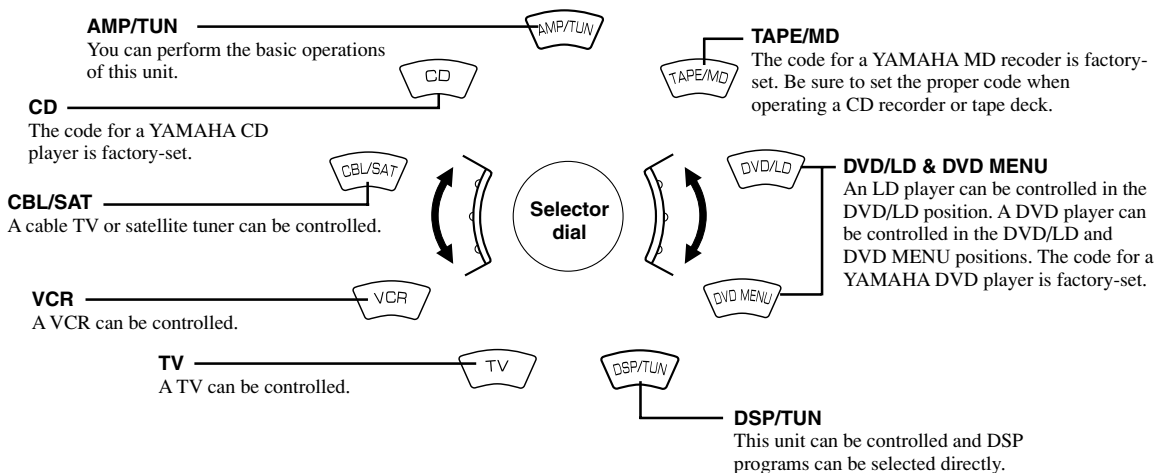

Notes

- The general operational buttons on the remote control differ depending on the position of the selector dial. See the following pages for details.
- When shipped from the factory, the YAMAHA manufacturer codes listed on page 54 are set for each dial position. If unable to operate your YAMAHA A/V component, please try using another YAMAHA code.

Commonly Used Buttons in Any Position of the Selector Dial

Regardless of the position of the selector dial, you can control this unit and your TV with the following buttons.

Note

- You have to set up the code for your TV in the TV position before you can control the TV.

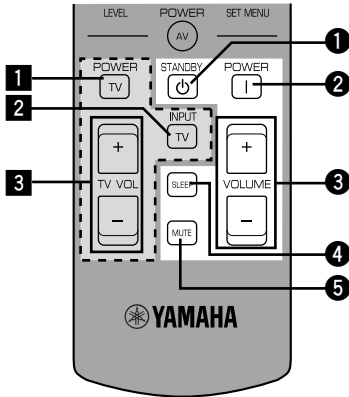

Controlling this unit

See "Remote Control".

- 1 STANDBY
- 2 POWER
- 3 VOLUME +/-
- 4 SLEEP

Note

- If you have set up the code for your TV and set the selector dial to the TV position, this button is used to set the sleep timer for the TV.

- 5 MUTE

Note

- If you have set up the code for your TV and set the selector dial to the TV position, this button is used to mute the TV sound.

Controlling your TV

- 1 TV POWER
- 2 TV INPUT
- 3 TV VOLUME +/-

Controlling the Components Connected to This Unit

The example below describes the procedure for controlling a YAMAHA CD player.

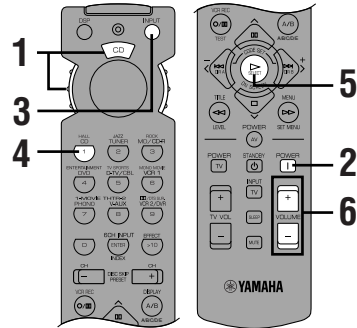

- 1 Set the selector dial to the CD position.



- 2 Turn on the power.



- 3 Press INPUT.

The indicator lights up for about 3 seconds.



- 4 Press CD while the indicator is lit.



- 5 Press .

See "Button Names and Functions in Each Position" for the CD player operation buttons.



- 6 Adjust the volume.



If you set the remote control with the manufacturer codes **listed from page i at the end of this manual**, you can control other brands of components. See "Setting the Manufacturer Codes" for details.

Button Names and Functions in Each Position

■ TAPE/MD position (tape deck, MD recorder or CD recorder)

Select the TAPE/MD position.

AV POWER
This button turns on the tape deck, MD recorder or CD recorder that has a remote control with a power button if you have set up the code for another manufacturer.

◀◀ DIR A (tape)
This button selects the playing direction of deck A.
Skip - (MD/CD-R)

▶ Play

⏸ Pause (MD/CD-R)

▶▶ DIR B (tape)
This button selects the playing direction of deck B.
Skip + (MD/CD-R)

◀◀ Rewind (tape)
Search (MD/CD-R)

0/1 Rec/Pause (tape/MD)

1-9 Numeric buttons (MD/CD-R)

INDEX (CD-R)

+10 (MD/CD-R)

Deck A/B (tape)
This button selects deck A or B on a double-cassette tape deck.

DISPLAY (MD/CD-R)

□ Stop

▶▶ Fast forward (tape)
Search (MD/CD-R)

■ CD position

Select the CD position.

DISC SKIP -/+ (for a CD player with CD changer)

▶ Play

◀◀ Skip -

◀◀ Search

1-9 Numeric buttons

INDEX

+10

DISPLAY

⏸ Pause
YAMAHA CD player (factory settings): Pause/Stop

▶▶ Skip +

□ Stop
YAMAHA CD player (factory settings): Pause/Stop

▶▶ Search

AV POWER
This button turns on the CD player that has a remote control with a power button if you have set up the code for another manufacturer.

☾ Pause/Stop function
• Press the button once to give a pause in operation and press once more to stop operation.

- The dark-shaded buttons do not function even if you have set up the manufacturer code.
- Some of them may not function depending on the component you have. In this case, use the original remote control supplied with your component.

DVD/LD position

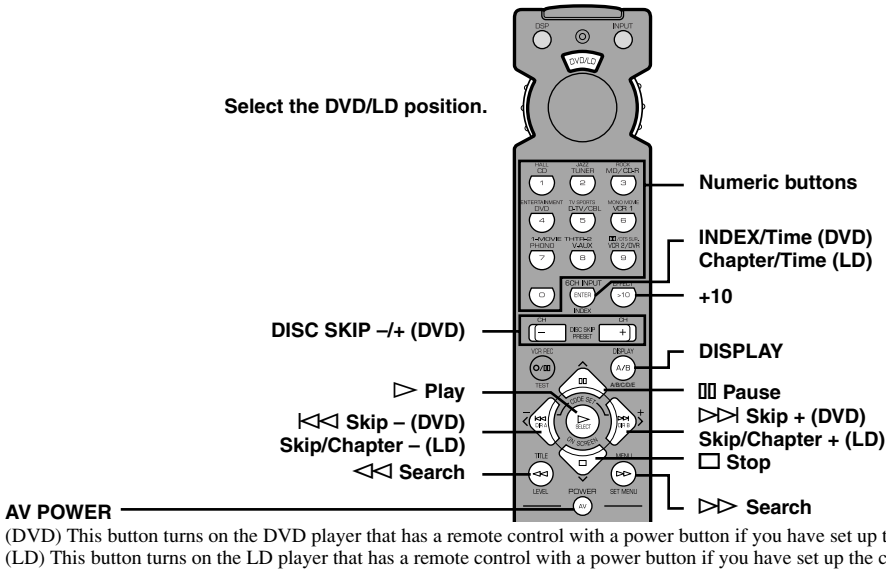

(DVD) This button turns on the DVD player that has a remote control with a power button if you have set up the code for another manufacturer.
 (LD) This button turns on the LD player that has a remote control with a power button if you have set up the code for another manufacturer.

DVD MENU position

Note

- DVD MENU operations cannot be performed for some DVD players.

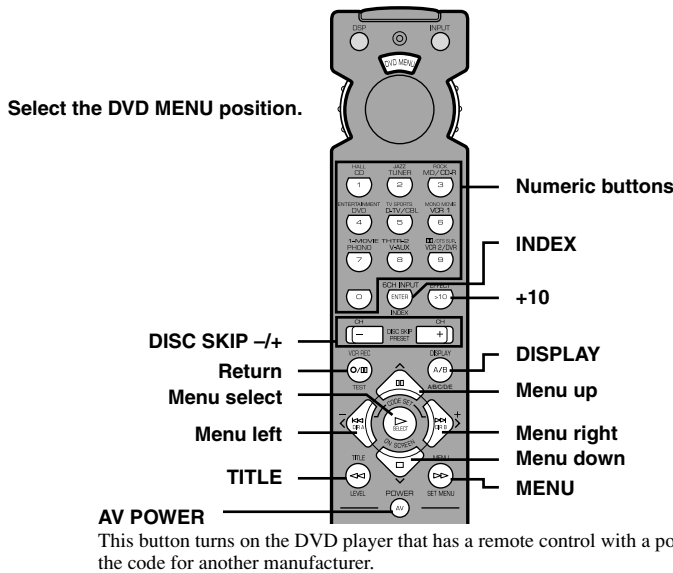

ADVANCED
OPERATION

- The dark-shaded buttons do not function even if you have set up the manufacturer code.
- Some of them may not function depending on the component you have. In this case, use the original remote control supplied with your component.

English

■ VCR position

■ CBL/SAT position

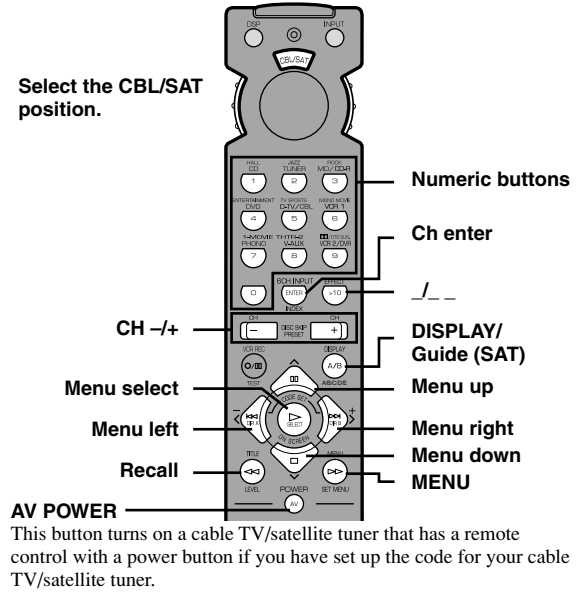
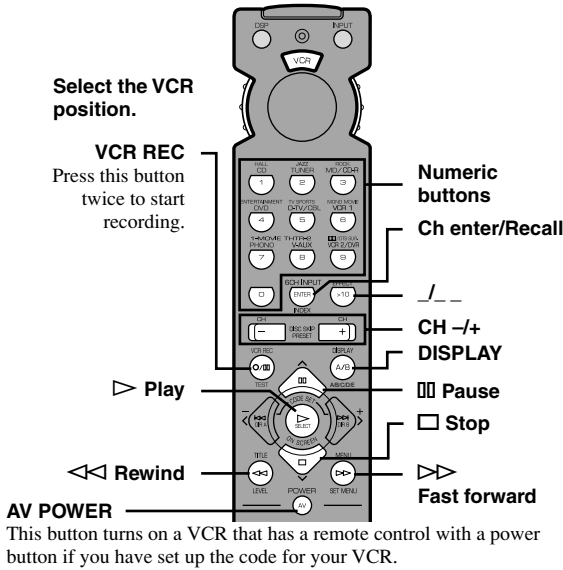

■ TV position

Note

- You can control your VCR if you have set up the code for it in the VCR position.

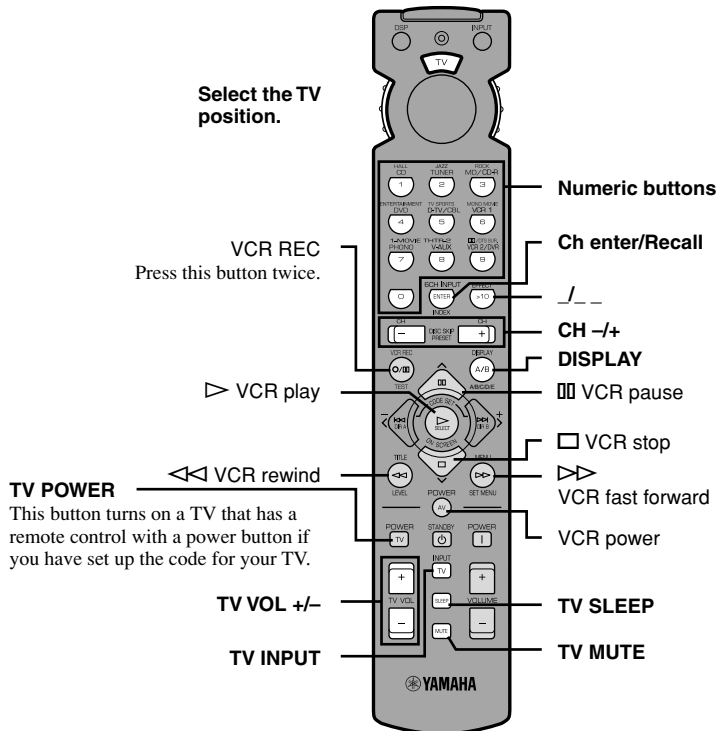

- The dark-shaded buttons do not function even if you have set up the manufacturer code.
- Some of them may not function depending on the component you have. In this case, use the original remote control supplied with your component.

Setting the Manufacturer Code

You can set up the code for the manufacturer of your component in each position of the selector dial.

1 Turn on your component to be used.

2 Set the selector dial to the desired position for the component (TAPE/MD, CD, DVD/LD, etc.).

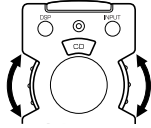

3 Press </> at the same time for about 4 seconds.

The indicator flashes twice.

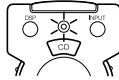
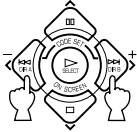

4 Use the numeric buttons to enter the four-digit manufacturer code for the component to be used. Make sure that the indicator flashes twice.

If the indicator does not flash or flashes rapidly several times, repeat step 3 and re-enter the code.

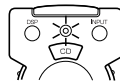
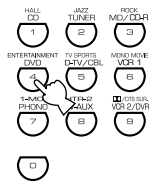

5 Press AV POWER (or any other button) to check if you have set up the code correctly.

If your component cannot be controlled with the remote control, try setting another code for the same manufacturer.



Notes

- You can set up only one code for one position.
- In the DVD/LD and DVD MENU positions: Be sure to set the selector dial to the DVD/LD position before entering the code for the DVD/LD player. You cannot set up the code for a DVD player when the selector dial is set to the DVD MENU position. The code set up in the DVD/LD position is also simultaneously set up in the DVD MENU position.
- If your component does not respond to any of the codes listed for the manufacturer, use the original remote control supplied with your component.

To use a second (and third) VCR

You can control a second (and third) VCR in the CBL/SAT and DVD MENU positions if a cable TV/satellite tuner or DVD player is not being used.

Note

- In order to set a second (and third) VCR in the DVD MENU position, it is necessary to first set up the code for an LD player in the DVD/LD position.

1 Turn on the VCR to be used.

2 Set the selector dial to the CBL/SAT or DVD MENU position.

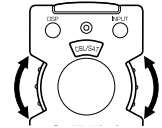

3 Press </> at the same time for about 4 seconds.

The indicator flashes twice.

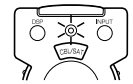
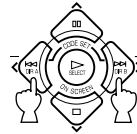

4 Use the numeric buttons to enter the four-digit code for the second (and third) VCR. Make sure that the indicator flashes twice.

If the indicator does not flash or flashes rapidly several times, repeat step 3 and re-enter the code.

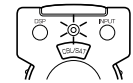
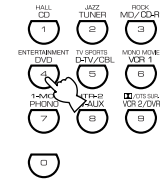

5 Press AV POWER (or any other button) to check if you have set up the code correctly.

If the VCR cannot be controlled with the remote control, try setting another code for the same manufacturer.



Returning to the Factory Setting

To return to the factory-set codes in all positions

1 Press **</>** at the same time for about 4 seconds.

The indicator flashes twice.

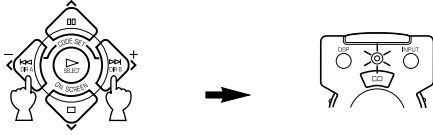

2 Enter the code number "9990".

Make sure that the indicator flashes twice.

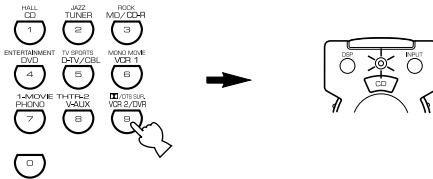

To return to the factory-set codes in each position

1 Set the selector dial to the position for the component to be returned to the factory setting.

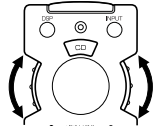

2 Press **</>** at the same time for about 4 seconds.

The indicator flashes twice.

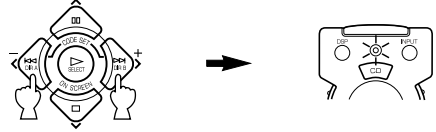

3 Enter the code number "0000".

Make sure that the indicator flashes twice.

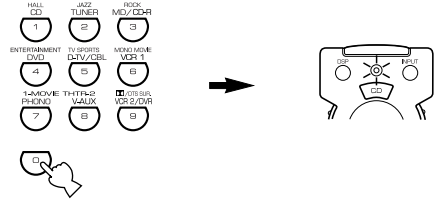

The following codes are factory set.

Selector dial position	Component	Code	Set component	Set code
TV	TV	0101		
CBL/SAT	Cable TV	0006		
VCR	VCR	0002		
DVD/LD	DVD player	0008 (YAMAHA DVD player)		
CD	CD player	0005 (YAMAHA CD player)		
TAPE/MD	MD recorder	0024 (YAMAHA MD recorder)		

We recommend that you write all the code numbers you have set on the table above.

SOUND FIELD PROGRAM

A digital sound field processor (DSP) based on the latest YAMAHA technology is built into this unit. It is possible to play back various sound fields for the source you are listening to.

Note

- Regardless of the program name and characteristics listed in the table below, select the sound field program that sounds best to you.

Hi-Fi DSP Programs

■ For audio sources: Nos. 1 to 4

No.	Program (group)	Sub-program	Features
1	CONCERT HALL	—	A large round concert hall with a rich surround effect. Pronounced reflections from all directions emphasize the extension of sounds. The sound field has a great deal of presence, and your virtual seat is near the center, close to the stage.
2	JAZZ CLUB	—	This is the sound field at stage front in “The Bottom Line”, a famous New York jazz club. The floor can seat 300 people to the left and right in a sound field offering a real and vibrant sound.
3	ROCK CONCERT	—	The ideal program for lively, dynamic rock music. The data for this program was recorded at LA’s “hottest” rock club. The listener’s virtual seat is at the center-left of the hall.
4	ENTERTAINMENT	DISCO	This program recreates the acoustic environment of a lively disco in the heart of a big city. The sound is dense and highly concentrated. It is also characterized by a high-energy, “immediate” sound.
		5CH STEREO	Using this program increases the listening position range. This is a sound field suitable for background music at parties.

Note

- Reverberations (sound effects) for realizing the sound field and unprocessed stereo from the left and right main speakers is output. The sound is not output from the center speaker. (The sound is output when one of these programs is selected while playing a source encoded with a Dolby Digital or DTS signal. If 5CH STEREO is selected, the sound is output from all speakers regardless of the input source.)

CINEMA DSP Programs



■ For audio-video sources: Nos. 4 to 6

No.	Program (group)	Sub-program	Features
4	ENTERTAINMENT	GAME	This program adds a deep and spatial feeling to video game sounds.
5	TV SPORTS	—	Although the presence sound field is relatively narrow, the surround sound field employs the sound environment of a large concert hall. With this program, you can enjoy watching various TV programs such as news, variety shows, music programs or sports programs. In a stereo broadcast of a sports game, the commentator is oriented at the center position, and the shouts and the atmosphere in the stadium spread on the surround side, while their spread to the rear is properly restrained.
6	MONO MOVIE	—	This program is provided for reproducing monaural video sources (such as old movies). The program produces the optimum reverberation to create sound depth by using only the presence sound field.

■ For movie programs: Nos. 7 to 9

No.	Program (group)	Sub-program		Input source	Features
7	MOVIE THEATER 1	SPECTACLE	70 mm SPECTACLE	Analog, PCM, Dolby Digital in 2-channel	This program creates the extremely wide sound field of a 70-mm movie theater. It precisely reproduces the source sound in detail, making both the video and the sound field incredibly real. This is ideal for any kind of video source encoded with Dolby Surround, Dolby Digital or DTS (especially large-scale movie productions).
			DGTL SPECTACLE	Dolby Digital (5.1-channel)	
			DTS SPECTACLE	DTS	
		SCI-FI	70 mm SCI-FI	Analog, PCM, Dolby Digital in 2-channel	This program clearly reproduces dialog and sound effects in the latest sound form of science fiction films, thus creating a broad and expansive cinematic space amid the silence. You can enjoy science fiction films in a virtual-space sound field that includes Dolby Surround, Dolby Digital and DTS-encoded software employing the most advanced techniques.
			DGTL SCI-FI	Dolby Digital (5.1-channel)	
			DTS SCI-FI	DTS	
8	MOVIE THEATER 2	ADVENTURE	70 mm ADVENTURE	Analog, PCM, Dolby Digital in 2-channel	This program is ideal for precisely reproducing the sound design of the newest 70-mm and multichannel soundtrack films. The sound field is made to be similar to that of the newest movie theaters, so the reverberations of the sound field itself are restrained as much as possible.
			DGTL ADVENTURE	Dolby Digital (5.1-channel)	
			DTS ADVENTURE	DTS	
		GENERAL	70 mm GENERAL	Analog, PCM, Dolby Digital in 2-channel	This program is for reproducing sounds from 70-mm and multichannel soundtrack films, and is characterized by a soft and extensive sound field. The presence sound field is relatively narrow. It spatially spreads all around and toward the screen, restraining the echo effect of conversations without losing clarity. For the surround sound field, the harmony of music or chorus sounds beautifully in a wide space at the rear of the sound field.
			DGTL GENERAL	Dolby Digital (5.1-channel)	
			DTS GENERAL	DTS	
9	Dolby Digital/DTS SURROUND	NORMAL	PRO LOGIC/NORMAL	Analog, PCM, Dolby Digital in 2-channel	The built-in decoder precisely reproduces sounds and sound effects from sources. The highly efficient decoding process improves crosstalk and channel separation, and makes sound positioning smoother and more precise. In this program, the digital sound field processor is not turned on.
			DOLBY DIGITAL/NORMAL	Dolby Digital (5.1-channel)	
			DTS DIGITAL SUR./NORMAL	DTS	
		ENHANCED	PRO LOGIC/ENHANCED	Analog, PCM, Dolby Digital in 2-channel	This program ideally simulates the multi-surround speaker systems of the 35-mm film theaters. Dolby Pro Logic decoding, Dolby Digital decoding or DTS decoding and digital sound field processing create precise effects without altering the original sound orientation. The surround effects produced by this sound field wrap around the viewer naturally from the back to the left and right, and toward the screen.
			DOLBY DIGITAL/ENHANCED	Dolby Digital (5.1-channel)	
			DTS DIGITAL SUR./ENHANCED	DTS	

Notes

- The “ DSP” indicator does not light up when selecting the sub-program “NORMAL” of the /DTS SURROUND program.
- If “1A CENTER SP” on the SET MENU is set to NONE, no sound is output from the center speaker.
- The effect sound is output from the main speakers when a monaural source is played with CINEMA DSP program groups 4 (GAME) and 5 to 8.

■ MOVIE THEATER 1 and 2

Most commercially available movie software has 4-channel (left, center, right and surround) sound information encoded by Dolby Surround matrix processing and stored on the left and right tracks. These signals are processed by the Dolby Pro Logic decoder. The MOVIE THEATER programs are designed to recreate the spaciousness and delicate nuances of sound that tend to be lost in the encoding and decoding processes.

The 6-channel soundtracks found on 70-mm film produce precise sound field localization and rich, deep sound without using matrix processing. This unit's MOVIE THEATER 70 mm programs provide the same quality of sound and sound localization that 6-channel soundtracks do.

When the input source is analog, PCM or encoded with Dolby Digital in 2-channel

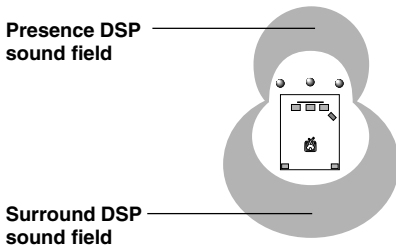

These programs express an immense sound field and a large surround effect. They also give depth to the sound from the main speakers to recreate the realistic sound of a Dolby Stereo theater.

70 mm SPECTACLE
70 mm SCI-FI
70 mm ADVENTURE
70 mm GENERAL

The built-in Dolby Digital or DTS decoder brings the professional-quality sound designed for movie theaters into your home. With the unit's MOVIE THEATER programs, you can recreate a dynamic sound that gives you the feeling of being at a public theater in your listening room by using Dolby Digital or DTS technology.

When the input source is encoded with Dolby Digital (5.1-channel) or DTS (Tri-Field CINEMA DSP)

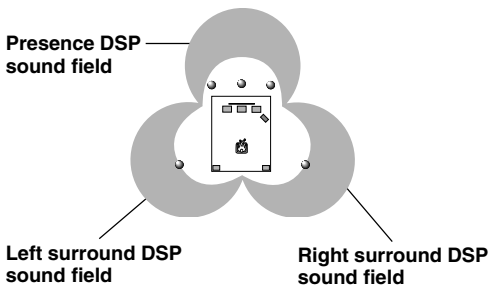

These programs use YAMAHA's tri-field DSP processing on each of the Dolby Digital or DTS signals for the front, left surround and right surround channels. This processing enables this unit to reproduce the immense sound field and surround expression of a Dolby Digital- or DTS-equipped movie theater without sacrificing the clear separation of all channels.

DGTL SPECTACLE
DTS SPECTACLE
DGTL SCI-FI
DTS SCI-FI
DGTL ADVENTURE
DTS ADVENTURE
DGTL GENERAL
DTS GENERAL



- If a Dolby Digital signal or DTS signal is input when the input mode is set to AUTO, the DSP program will be automatically switched to the Dolby Digital playback sound field or DTS playback sound field.

SOUND FIELD PROGRAM PARAMETER EDITING

What is a sound field?

What really creates the rich, full tones of a live instrument are the multiple reflections from the walls of the room. In addition to making the sound “live”, these reflections enable us to tell where the player is situated, and the size and shape of the room in which we are sitting.

■ Elements of a sound field

In any environment, in addition to the direct sound coming straight to our ears from the player’s instrument, there are two distinct types of sound reflections that combine to make up the sound field:

Early reflections

Reflected sounds reach our ears extremely rapidly (50 ms – 100 ms after the direct sound), after reflecting from one surface only — for example, from the ceiling or a wall. These reflections fall into specific patterns for any particular environment, and provide vital information to our ears. Early reflections actually add clarity to the direct sound.

Reverberations

These are caused by reflections from more than one surface — walls, ceiling, the back of the room — so numerous that they merge together to form a continuous sonic “afterglow”. They are non-directional, and lessen the clarity of the direct sound.

Direct sound, early reflections and subsequent reverberation taken together help us to determine the subjective size and shape of the room, and it is this information that the digital sound field processor reproduces in order to create sound fields.

If you could create the appropriate early reflections and subsequent reverberations in your listening room, you would be able to create your own listening environment. The acoustics in your room could be changed to those of a concert hall, a dance floor, or virtually any size room at all. This ability to create sound fields at will is exactly what YAMAHA has done with the digital sound field processor.

Sound Field Program Parameters

DSP programs consist of some parameters to determine the apparent room size, reverberation time, distance from you to the performer, etc. In each program, these parameters are set with values precisely calculated by YAMAHA to create a sound field unique to the program. It is recommended to use DSP programs without changing the values of parameters; however, this unit also allows you to create your own sound fields. Starting with one of the built-in programs, you can adjust those parameters.

Each DSP program has a set of parameters that allow you to change the characteristics of the acoustic environment to precisely create the effect you want. These parameters correspond to the many natural acoustic factors that create the sound field you experience in an actual concert hall or other listening environment. The size of the room, for example, affects the length of time between the early reflections. The “ROOM SIZE” parameter provided in many of the DSP programs alters the timing between these reflections, thus changing the shape of the “room” you are listening. In addition to room size, the shape of the room and the characteristics of its surfaces have a significant effect on the final sound. Surfaces that absorb sound, for example, cause the reflections and reverberations to die out more quickly, while highly reflective surfaces allow the reflections to carry on for a longer period of time. The digital sound field parameters allow you to control these and many other factors that contribute to your personal sound field, allowing you to essentially “redesign” the concert halls, theaters, etc. provided to create custom-tailored listening environments that ideally match your mood and music.

See “Sound Field Parameter Descriptions”.

Changing Parameter Settings

Although it is possible to enjoy playback on your system without changing default setting parameters for the sound field program, it is also possible to enjoy specifically tailor the sound field program to the characteristics of the source and the acoustics of the listening room.

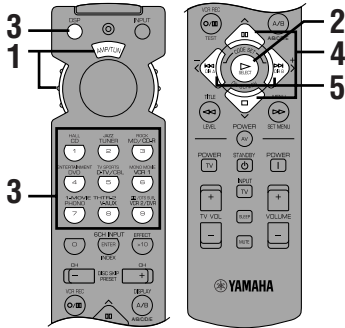

1 Set the selector dial to the DSP/TUN (or AMP/TUN) position.

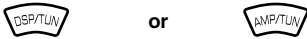

2 Turn on the video monitor and press ON SCREEN repeatedly to select the full display mode.



3 Select a DSP program you want to adjust.

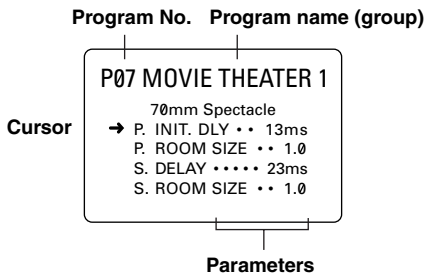
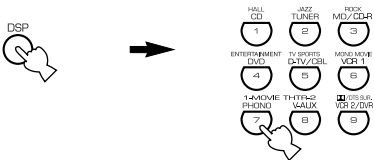

Example of the MOVIE THEATER 1

4 Press \swarrow to select the parameter.

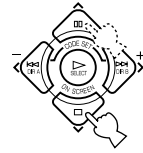

5 Press \langle / \rangle to change the parameter value.

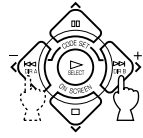

• When you set the parameter to a value other than the factory-set value, an asterisk mark (*) appears by the parameter name on the video monitor.

6 Repeat steps 3 to 5 above as necessary to change other program parameters.

Memory back-up

The memory back-up circuit prevents the stored data from being lost even if this unit is set in the standby mode, the power cord is disconnected from the AC outlet, or the power supply is temporarily cut due to power failure. However, if the power is cut for more than one week, the parameter value you edited will return to the factory setting. If so, edit the parameter value again.

Resetting a Parameter to the Factory-set Value

Select the parameter you want to reset. Then press and hold \langle or \rangle until the value temporarily stops at the factory-set value. The asterisk mark (*) by the parameter name disappears on the video monitor.

Notes

- The available parameters may be displayed on more than one OSD page for some of the programs. To scroll through pages, press \swarrow .
- You cannot change parameter values when “10 MEMORY GUARD” on the SET MENU is set to ON. If you want to change the parameter values, set “10 MEMORY GUARD” to OFF.

Sound Field Parameter Descriptions

You can adjust the values of certain sound field parameters so the sound fields are recreated accurately in your listening room.

Note

- Not all of the following parameters can be found in every program.

■ INIT.DLY (initial delay) (P.INIT.DLY — for the presence sound field)

Function: This parameter changes the apparent distance from the sound source by adjusting the delay between the direct sound and the first reflection heard by the listener.

Control range: 1 – 99 msec

Description: The smaller the value, the closer the sound source seems to the listener. The larger the value, the farther the apparent distance seems. For a small room, this parameter would be set to a small value, for a large room, set it to a large value.

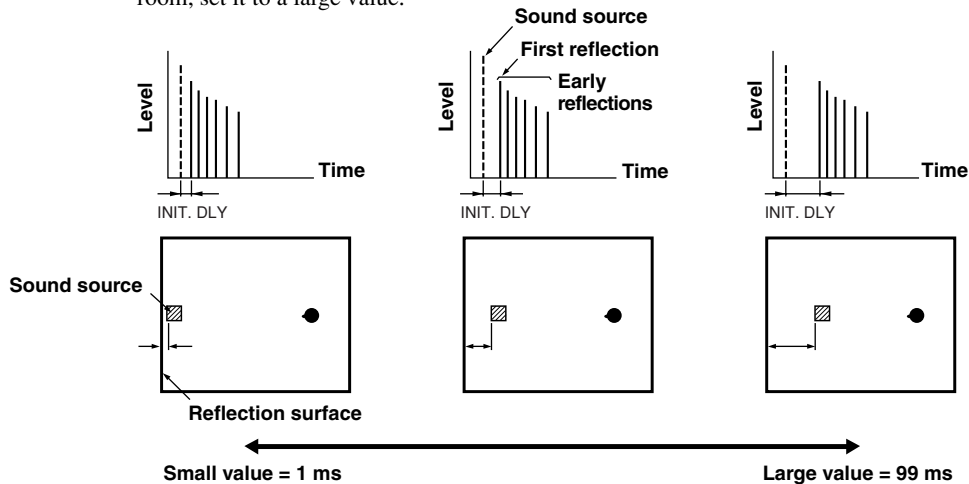

■ ROOM SIZE (P.ROOM SIZE — for the presence sound field)

Function: This parameter adjusts the apparent size of the surround sound field. The larger the value, the larger the surround sound field becomes.

Control range: 0.1 – 2.0

Description: As the sound is repeatedly reflected around a room, the larger the hall is, the longer the time between the original reflected sound and the subsequent reflections. By controlling the time between the reflected sounds, you can change the apparent size of the virtual venue. Changing this parameter from one to two, doubles the apparent length of the room.

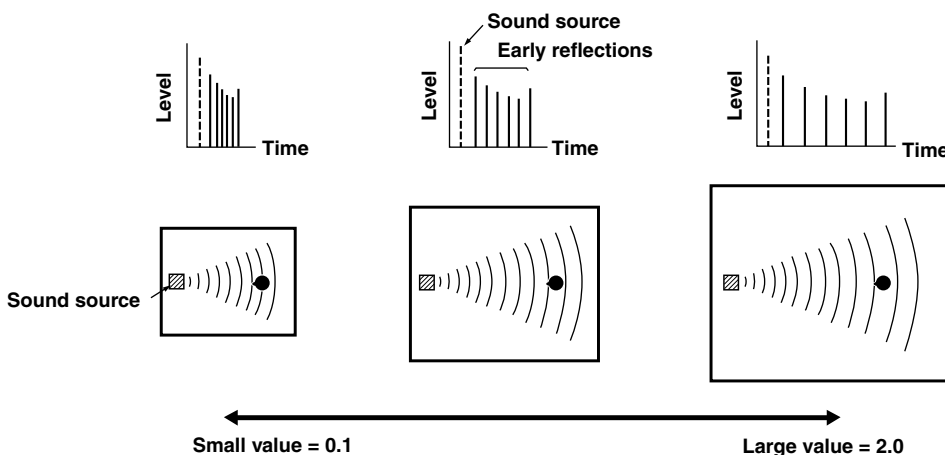

■ LIVENESS

Function: This parameter adjusts the reflectivity of the virtual walls in the hall by changing the rate at which the early reflections decay.

Control range: 0 – 10

Description: The early reflections of a sound source decay much faster in a room with acoustically absorbent wall surfaces than in one which has highly reflective surfaces. A room with acoustically absorbent surfaces is referred to as “dead,” while a room with highly reflective surfaces is referred to as “live”. The “LIVENESS” parameter lets you adjust the early reflection decay rate, and thus the “liveness” of the room.

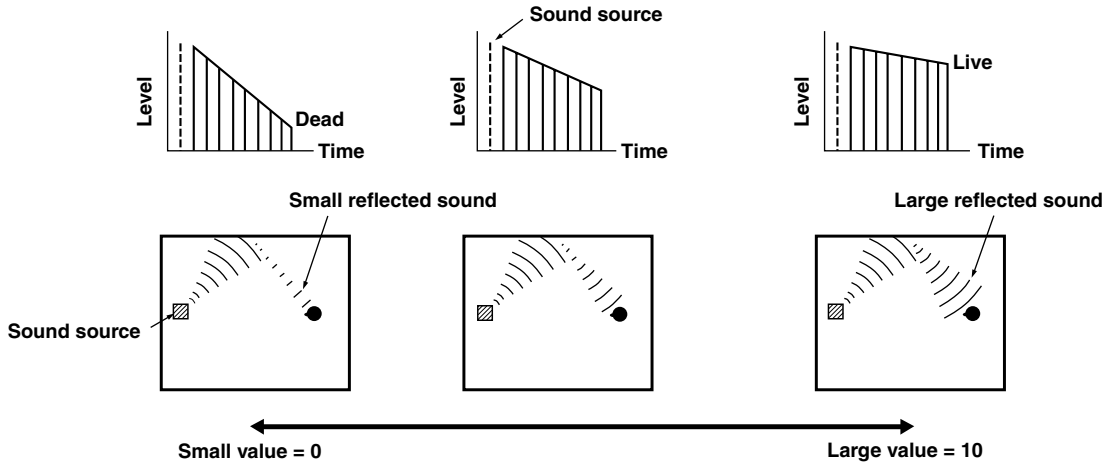

■ S.DELAY (surround delay)

Function: This parameter adjusts the delay between the direct sound and the first reflection in the surround sound field.

Control range: 0 – 49 msec (The range depends on the signal format.)

■ S.INIT.DLY (surround initial delay)

Function: This parameter adjusts the delay between the direct sound and the first reflection on the surround side of the sound field. You can only adjust this parameter when at least two front channels and two rear channels are used.

Control range: 1 – 49 msec

■ **S.ROOM SIZE (surround room size)**

Function: This parameter adjusts the apparent size of the surround sound field.

Control range: 0.1 – 2.0

■ **S.LIVENESS (surround liveness)**

Function: This parameter adjusts the apparent reflectivity of the virtual walls in the surround sound field.

Control range: 0 – 10

■ **CT.DELAY (center delay)**

Function: These parameters adjust the sound delay for each channel in 5 channel stereo mode.

Control range: 0 – 50 msec

■ **LS.DELAY (left surround delay)**

Function: These parameters adjust the sound delay for each channel in 5 channel stereo mode.

Control range: 0 – 50 msec

■ **RS.DELAY (right surround delay)**

Function: These parameters adjust the sound delay for each channel in 5 channel stereo mode.

Control range: 0 – 50 msec

TROUBLESHOOTING

Refer to the chart below when the unit does not function properly. If the problem you are experiencing is not listed below or if the instruction below does not help, set this unit in the standby mode, disconnect the power cord and contact the nearest authorized YAMAHA dealer or service center.

■ General

Problem	Cause	Remedy	Refer to page
The unit fails to turn on when STANDBY/ON (or POWER) is pressed, or enters in the standby mode soon after the power has been turned on.	The power cord is not connected or the plug is not completely inserted.	Firmly connect the power cord.	19
	The IMPEDANCE SELECTOR switch on the rear panel is not fully set to the left or right position.	Set the switch fully to the left or right position when the unit is in the standby mode.	19
	The protection circuitry has been activated.	Make sure all speaker wire connections on this unit and on all speakers are secure and that the wire for each connection does not touch anything other than its respective connection.	16, 17
On-screen display does not appear.	The setting for the on-screen display is set to "DISPLAY OFF".	Select the full display or short display mode.	20
	The BLUE BACK setting under "9 DISPLAY SET" on the SET MENU is set to OFF, and no video signal is input to this unit.	Set BLUE BACK to AUTO to always show the OSD.	45
No sound and/or no picture.	Incorrect input or output cable connections.	Connect the cables properly. If the problem persists, the cables may be defective.	12 – 15
	An appropriate input source has not been selected.	Select an appropriate input source with INPUT < /> or 6CH INPUT (or the input selector buttons).	24
	The speaker connections are not secure.	Secure the connections.	16, 17
	The main speakers to be used have not been selected properly.	Select the main speakers with SPEAKERS A and/or B.	24
	The volume is turned down.	Turn up the volume.	25
	The sound is muted.	Press MUTE or any operation buttons to cancel a mute and adjust the volume.	25
	Digital signals other than PCM audio, Dolby Digital or DTS signal which this unit cannot reproduce are being input to this unit by playing a CD-ROM, etc.	Play a source whose signals this unit can reproduce.	—
The picture does not appear.	The output and input for the video are connected to different types of video jacks.	Make connections using the same type of jack (between composites, S-VIDEOS, or components) for both the input and output.	14, 15
The sound suddenly goes off.	The protection circuit has been activated because of a short circuit, etc.	Check the IMPEDANCE SELECTOR switch is set to the appropriate position and then turn the unit back on.	19
		Check the speaker wires are not touching each other and then turn the unit back on.	16, 17
	The sleep timer has functioned.	Turn on the power, and play the source again.	47
	The sound is muted.	Press MUTE or any operation buttons to cancel a mute and adjust the volume.	25
Only the speaker on one side can be heard.	Incorrect cable connections.	Connect the cables properly. If the problem persists, the cables may be defective.	12 – 17

Problem	Cause	Remedy	Refer to page
No sound from the effect speakers.	The sound effect is off.	Press EFFECT to turn it on.	29
	A Dolby Surround, Dolby Digital or DTS decoding DSP program is being used with material not encoded with Dolby Surround, Dolby Digital or DTS.	Select another DSP program.	55, 56
	A 96-kHz sampling digital signal is being input to this unit.		25
No sound from the center speaker.	The output level of the center speaker is set to minimum.	Raise the level of the center speaker.	46
	“1A CENTER SP” on the SET MENU is set to NONE.	Select the appropriate mode for your center speaker.	40
	One of the Hi-Fi DSP programs (1 to 4) has been selected.	Select another DSP program.	55, 56
	The source encoded with a Dolby Digital or DTS signal does not have a center channel signal.		—
No sound from the rear speakers.	The output level of the rear speakers is set to minimum.	Raise the output level of the rear speakers.	46
	A monaural source is being played with the program 9.	Select another DSP program.	55, 56
No sound from the subwoofer.	“1D LFE/BASS OUT” on the SET MENU is set to MAIN when a Dolby Digital or DTS signal is being played.	Select SWFR or BOTH.	42
	“1D LFE/BASS OUT” on the SET MENU is set to SWFR or MAIN when a 2-channel source is being played.	Select BOTH.	42
	The source does not contain low bass signals (90 Hz and below).		—
Poor bass reproduction.	“1D LFE/BASS OUT” on the SET MENU is set to SWFR or BOTH and your system does not include a subwoofer.	Select MAIN.	42
	The output mode for each speaker (main, center or rear) on the SET MENU does not match your speaker configuration.	Select the appropriate output mode for each speaker based on the size of the speakers in your configuration.	40, 41
A “humming” sound can be heard.	Incorrect cable connections.	Firmly connect the audio plugs. If the problem persists, the cables may be defective.	12 – 15
	No connection from the turntable to the GND terminal.	Connect the grounding cord of your turntable to the GND terminal of this unit.	12, 13
The volume level is low while playing a record.	The record is being played on a turntable with an MC cartridge.	The turntable should be connected to the unit through an MC-head amplifier.	12

Problem	Cause	Remedy	Refer to page
The volume level cannot be increased, or the sound is distorted.	The component connected to the REC OUT jacks of this unit is turned off.	Turn on the power to the component.	12
The effect and surround sounds cannot be recorded.	It is not possible to record the effect and surround sounds by a recording component.		38
A source cannot be recorded by a digital recording component connected to the DIGITAL OUTPUT jack of this unit.	A source component is only connected to the analog input jacks of this unit.	Connect the source component to the digital input jacks of this unit.	12 – 15
The sound field parameters and some other settings on this unit cannot be changed.	“10 MEMORY GUARD” on the SET MENU is set to ON.	Select OFF.	45
When TUNER is selected, the DSP program name shown on the display immediately changes to the frequency.	The OSD mode is set to short display or display off.	If you want the DSP program name display to be shown constantly, set the OSD mode to full display.	20
This unit does not operate properly.	The internal microcomputer has been frozen by an external electric shock (such as lightning or excessive static electricity) or by a power supply with low voltage.	Disconnect the AC power cord from the outlet and then plug it in again after about 30 seconds.	—
The sound is degraded when listening with headphones connected to a tape deck or CD player that is connected to this unit.	This unit is in the standby mode.	Turn on the power of the unit.	—
There is noise interference from digital or high-frequency equipment, or the unit.	The unit is too close to the digital or high-frequency equipment.	Move the unit further away from such equipment.	—

■ Tuner

	Problem	Cause	Remedy	Refer to page
FM	FM stereo reception is noisy.	The characteristics of FM stereo broadcasts may cause this problem when the transmitter is too far away or the antenna input is poor.	Check the antenna connections. Try using a high-quality directional FM antenna. Use the manual tuning method.	30, 31
	There is distortion, and clear reception cannot be obtained even with a good FM antenna.	There is multipath interference.	Adjust the antenna position to eliminate multipath interference.	30
	The desired station cannot be tuned in with the automatic tuning method.	The station is too weak.	Use the manual tuning method. Use a high-quality directional FM antenna.	30, 31
	Previously preset stations can no longer be tuned in.	The unit has been disconnected for a long period.	Re-store the stations.	32
AM	The desired station cannot be tuned in with the automatic tuning method.	The signal is weak or the antenna connections are loose.	Tighten the AM loop antenna connections and orient it for best reception. Use the manual tuning method.	30, 31
	There are continuous crackling and hissing noises.	Noises result from lightning, fluorescent lamps, motors, thermostats and other electrical equipment.	Use an outdoor antenna and a ground wire. This will help somewhat, but it is difficult to eliminate all noise.	30
	There are buzzing and whining noises (especially in the evening).	A TV set is being used nearby.	Move this unit away from the TV.	—

■ Remote control

Problem	Cause	Remedy	Refer to page
The remote control does not work nor function properly.	Wrong distance or angle.	The remote control will function within a maximum range of 6 m (20 feet) and no more than 30 degrees off-axis from the front panel.	8
	Direct sunlight or lighting (from an inverter type of fluorescent lamp, etc.) is striking the remote control sensor of this unit.	Reposition the unit.	—
	The batteries are weak.	Replace all batteries with new ones.	3
The unit or other component cannot be controlled.	The component to be controlled has not been selected.	Set the selector dial to the appropriate position, corresponding to the component to be controlled.	48
	The remote control cannot control system components.		—
	The manufacturer code has not been set up properly.	Enter the code again.	53
		Try setting another code for the same manufacturer.	
Depending on the manufacturer or the model, some components cannot be controlled with this unit's remote control even though the code has been set up properly.	Use the original remote control supplied with your component.	—	

After this unit has been exposed to a strong external electric shock (such as lightning and strong static electricity) or if you mishandle the operation of this unit, it may not function properly. In these cases, set this unit in the standby mode, disconnect the power cord, plug it back in after 30 seconds, and start operating.

SPECIFICATIONS

AUDIO SECTION

- Minimum RMS Output Power for Main, Center, Rear
 - 20 Hz to 20 kHz, 0.06% THD, 8 ohms 90 W
 - 1 kHz, 0.06% THD, 8 ohms 100 W
- DIN Standard Output Power
 - [Europe model only]
 - 1 kHz, 0.7% THD, 4 ohms 130 W
- IEC Output Power
 - [Europe model only]
 - 1 kHz, 0.06% THD, 8 ohms 100 W
- Dynamic Power (IHF)
 - 8/6/4/2 ohms 120/140/175/210 W
- Damping Factor
 - 20 Hz to 20 kHz, 8 ohms 80 or more
- Frequency Response
 - CD to Main L/R 10 Hz to 100 kHz, -3 dB
- RIAA Equalization Deviation
 - PHONO (MM) ± 0.5 dB
- Total Harmonic Distortion
 - PHONO MM (20 Hz to 20 kHz, 1 V, REC OUT) 0.02% or less
 - CD, etc. (20 Hz to 20 kHz, 45 W, 8 ohms, Main L/R)
 - 0.06% or less
- Signal to Noise Ratio (IHF-A Network)
 - PHONO MM to REC OUT (5 mV, shorted) 81 dB or more
 - CD (250 mV, shorted) to Main L/R, Effect Off 100 dB or more
- Residual Noise (IHF-A Network)
 - Main L/R 150 μ V or less
- Channel Separation (1 kHz/10 kHz)
 - CD (5.1 kohms terminated) to Main L/R 60 dB/45 dB
- Tone Control (Main L/R)
 - BASS Boost/Cut ± 10 dB/50 Hz
 - TREBLE Boost/Cut ± 10 dB/20 kHz
 - BASS EXTENSION +6 dB/60 Hz
- Phones Output 400 mV/560 ohms
- Input Sensitivity
 - CD, etc 150 mV/47 kohms
 - PHONO 2.5 mV/47 kohms
 - 6CH INPUT 150 mV/47 kohms
- Maximum Input Signal
 - PHONO MM (1 kHz, 0.1% THD) 100 mV or more
 - CD, etc. (1 kHz, 0.5% THD) 2.2 V or more
- Output Level
 - REC OUT 150 mV/1.2 kohms
 - PRE OUT 2.1 V/1.2 kohms
 - SUBWOOFER 4.0 V/1.2 kohms

VIDEO SECTION

- Video Signal Type PAL
- Composite Video Signal Level 1 Vp-p/75 ohms
- S-Video Signal Level
 - Y 1 Vp-p/75 ohms
 - C 0.286 Vp-p/75 ohms
- Component Video Signal Level
 - Y 1 Vp-p/75 ohms
 - Pb/Cb, Pr/Cr 0.7 Vp-p/75 ohms
- Signal to Noise Ratio 50 dB or more
- Frequency Response (MONITOR OUT)
 - Composite, S-Video 5 Hz to 10 MHz, -3 dB
 - Component DC to 30 MHz, -3 dB

FM SECTION

- Tuning Range 87.50 to 108.00 MHz
- 50 dB Quieting Sensitivity (IHF, 100% mod.)
 - Mono/Stereo 1.6 μ V (15.3 dBf) /23 μ V (38.5 dBf)
- Alternate Channel Selectivity (400 kHz) 75 dB
- Signal to Noise Ratio (IHF)
 - Mono/Stereo 81 dB/75 dB
- Harmonic Distortion (1 kHz)
 - Mono/Stereo 0.1%/0.2%
- Stereo Separation (1 kHz) 48 dB
- Frequency Response (20 Hz to 15 kHz) ± 1 dB

AM SECTION

- Tuning Range 531 to 1611 kHz
- Usable Sensitivity 300 μ V/m
- Signal to Noise Ratio 52 dB

GENERAL

- Power Supply AC 230 V/50 Hz
- Power Consumption 260 W
- Standby Mode 0.9 W
- AC Outlets (Total 100 W maximum)
 - [Europe model] 2 (SWITCHED)
 - [U.K. model] 1 (SWITCHED)
- Dimension (W x H x D) 435 x 151 x 390 mm
- Weight 10.5 kg
- Accessories Remote Control
 - Batteries
 - AM loop antenna
 - Indoor FM antenna
 - 75-ohm/300-ohm antenna adapter (U.K. model only)
 - Quick Reference Card
 - Connection Guide

* Specifications are subject to change without notice.

GLOSSARY

■ Dolby Surround

Dolby Surround uses a four analog channel recording system to reproduce realistic and dynamic sound effects: two left and right main channels (stereo), a center channel for dialog (monaural), and a rear channel for special sound effects (monaural). The rear channel reproduces sound within a narrow frequency range.

Dolby Surround is widely used with nearly all video tapes and laser discs, and in many TV and cable broadcasts as well. The Dolby Pro Logic decoder built into this unit employs a digital signal processing system that automatically stabilizes the volume on each channel to enhance moving sound effects and directionality.

■ Dolby Digital

Dolby Digital is a digital surround sound system that gives you completely independent multi-channel audio. With three front channels (left, center and right), and two rear stereo channels, Dolby Digital provides five full-range audio channels. With an additional channel especially for bass effects, called LFE (low frequency effect), the system has a total of 5.1 channels (LFE is counted as 0.1 channel).

Using two-channel stereo for the rear speakers, more accurate moving sound effects and surround sound environment are possible than with Dolby Surround. The wide dynamic range (from maximum to minimum volume) reproduced by the five full-range channels and the precise sound orientation generated using digital sound processing provide listeners with previously unheard of excitement and realism.

With this unit, any sound environment from monaural up to a 5.1-channel configuration can be freely selected for your enjoyment.

■ DTS (Digital Theater Systems) Digital Surround

DTS digital surround was developed to replace the analog soundtracks of movies with a six-channel digital sound track, and is now rapidly gaining popularity in movie theaters around the world. Digital Theater Systems Inc. has developed a home theater system so that you can enjoy the depth of sound and natural spatial representation of DTS digital surround in your home. This system is practically distortion-free, clear 6-channel sound (technically, a left, right and center channels, two rear channels, plus an LFE 0.1 channel as a subwoofer, for a total of 5.1 channels).

■ LFE 0.1 channel

This channel is for the reproduction of low bass signals. The frequency range for this channel is 20 Hz to 120 Hz. This channel is counted as 0.1 because it only enforces a low frequency range compared to the full-range reproduced by the other 5 channels in a Dolby Digital or DTS 5.1 channel systems.

■ CINEMA DSP

Since the Dolby Surround and DTS systems were originally designed for use in movie theaters, their effect is best felt in a theater having many speakers and designed for acoustic effects. Since home conditions, such as room size, wall material, number of speakers, and so on, can differ so widely, it's inevitable that there are differences in the sound heard as well. Based on a wealth of actually measured data, YAMAHA CINEMA DSP uses YAMAHA original sound field technology to combine Dolby Pro Logic, Dolby Digital and DTS systems to provide the visual and audio experience of movie theater in the listening room of your own home.

■ SILENT CINEMA

YAMAHA has developed a natural, realistic sound effect DSP algorithm for headphones. Parameters for headphones have been set for each sound field so that accurate representations of all the sound field programs can be enjoyed on headphones.

■ Virtual CINEMA DSP

YAMAHA has developed a virtual CINEMA DSP algorithm that allows you to enjoy DSP sound field surround effects even without any rear speakers by using virtual rear speakers.

It is even possible to enjoy virtual CINEMA DSP in a minimum two-speaker system that does not include a center speaker.

■ S VIDEO signal

With S VIDEO signal system, the video signal normally transmitted using a pin cable is separated and transmitted as the Y signal for the luminance and the C signal for the chrominance through the S VIDEO cable. Using the S VIDEO jack eliminates video signal transmission loss and allows recording and playback of even more beautiful images.

■ Component video signal

With the component video signal system, the video signal is separated into the Y signal for the luminance and the P_B/C_B and P_R/C_R signals for the chrominance. Color can be reproduced more faithfully with this system because each of these signals is independent. The component signal is also called the “color difference signal” because the luminance signal is subtracted from the color signal. A monitor with component input jacks is required in order to use the component signal for output.

■ PCM (Linear PCM)

Linear PCM is a signal format under which an analog audio signal is digitized, recorded and transmitted without using any compression. This is used as a method of recording CDs and DVD audio. The PCM system uses a technique for sampling the size of the analog signal per very small unit of time. Standing for “pulse code modulation”, the analog signal is encoded as pulses and then modulated for recording.

■ Sampling frequency and number of quantized bits

When digitizing an analog audio signal, the number of times the signal is sampled per second is called the sampling frequency, while the degree of fineness when converting the sound level into a numeric value is called the number of quantized bits.

The range of rates that can be played back is determined based on the sampling rate, while the dynamic range representing the sound level difference is determined by the number of quantized bits. In principle, the higher the sampling frequency, the wider the range of frequencies that can be played back, and the higher the number of quantized bits, the more finely the sound level can be reproduced.

■ I/O assignment (SET MENU)

Although component is normally connected according to jack names shown on the rear panel, this unit includes a function that assigns jacks according to the component being connected. If the component being used differs from the component name shown for this unit’s component video input jacks or digital input/output jacks, it is possible to assign jacks according to the component being connected. This makes it possible to change the jack assignment and effectively connect more component.

INDEX

A	
Accessories	3
AC outlets	19
Antennas	30
B	
Balance (L/R BALANCE) (SET MENU)	42
BGV function	26
C	
CBL/SAT position	52
CD position	50
CINEMA DSP	55, 69
Component video	70
Connections	
Antennas	30
Audio components (MD recorder, CD recorder, CD player and turntable)	12
External amplifier	18
External decoder	18
Power supply cords	19
Speakers	16
Video components (DVD player, VCR and TV/digital TV or cable TV/satellite tuner)	14
D	
Delay time	45
DISPLAY SET (SET MENU)	
BLUE BACK	45
DIMMER	45
OSD SHIFT	45
DOLBY D. SET (SET MENU)	
D-RANGE	44
LFE LEVEL	44
Dolby Digital	69
Dolby Surround (Dolby Pro Logic)	69
DSP program	
CINEMA DSP program	55
Hi-Fi DSP program	55
DTS	69
DTS SET (SET MENU)	44
Dust protection cap	12
DVD/LD position	51
DVD MENU position	51
E	
External decoder	18
F	
Front panel	4
Front panel display	9
H	
HP TONE CTRL (SET MENU)	43
I	
IMPEDANCE SELECTOR switch	19
INPUT MODE (SET MENU)	43
Input modes	26
I/O ASSIGNMENT (SET MENU)	43, 70
L	
LFE	44, 69
M	
Manufacturer codes	53, i
Memory back-up	32, 40, 46, 59
MEMORY GUARD (SET MENU)	45
Muting	25
P	
PCM	70
PHONO jacks	12
Playing	24
Power supply cords	19
Preset stations	
Exchanging preset station	34
Tuning in to a preset station	33
Presetting stations	
Automatic presetting	32
Manual presetting	33
R	
RDS stations	
EON function	37
PTY SEEK function	36
RDS mode	35
Rear panel	10
Recording	38
Remote control	
Basic operation	6
Batteries	3
Operation range	8
Setup codes	53
S	
Sampling frequency	25, 70
Selector dial	6, 48
SET MENU	39
SILENT CINEMA	29, 69
Sleep timer	47
Sound field	58
SP DELAY TIME (SET MENU)	45
Speaker	
Output levels (LEVEL mode)	46
Output mode (SET MENU)	21
Placement	11
Output balance (test tone)	22
SPEAKER SET (SET MENU)	
CENTER SP	40
LFE/BASS OUT	42
MAIN LEVEL	42
MAIN SP	41
REAR L/R SP	41
Stereo reproduction	29
Subwoofer	17
S VIDEO	70
T	
TAPE/MD position	50
Test tone (TEST DOLBY SUR.)	22
Tuning	
Automatic tuning	31
Manual tuning	31
TV position	52
V	
VCR position	52
Video jacks	14
Virtual CINEMA DSP	29, 69

**LIST OF MANUFACTURER'S CODES
LISTES DES CODES FABRICANT
VERZEICHNIS DER HERSTELLERCODES
LISTA ÖVER TILLVERKARKODER
ELENCO DEI CODICI DEL FABBRICANTE
LISTA DE CÓDIGOS DE FABRICANTES
LIJST VAN CODES VAN FABRIKANT**

TV		CLARIVOX 0821, 0961, 1971	FIRST LINE 1981	HITACHI 0001, 0011, 0031,
ADMIRAL 0411, 0451, 0911,		CLATRONIC 1181, 1331	FISHER 0021, 0091, 0141,	0081, 0141, 0291,
1021, 1081		CONCERTO 0791	0511, 0601, 0801,	0331, 0341, 0451,
AIKO 0891		CONDOR 0761	0821, 0981, 1021,	0601, 0631, 0701,
AKAI 0061, 0101, 0231,		CONTEC 0151, 1171	1081, 1981, 2091	1281, 1561, 1601,
1191, 1351, 1591,		CONTINENTAL EDISON	FORGESTONE 2281	1821, 1831, 1841,
1641, 1791, 1891,		0571, 0651, 0901	FORMENTI 0451, 0491, 0761,	1861, 1871, 1881,
1981		CRAIG 1171	1081, 1451, 1541,	1891, 1941, 1981,
AKURA 1331		CROSLEY 0021, 0491, 1021,	1981	2051, 2321, 2341
ALBA 1241, 1331, 2361		1081, 1401, 1981,	FORMENTI-PHOENIX	HYPER 0591, 0601, 1511,
ALBIRAL 1971		2201, 2251, 2271	0021, 0431, 0451,	1621
AMSTRAD 1301, 1511		CROWN 2541	0591, 1411	IMPERIAL 0451, 0491, 0811,
ANAM 1171		CTC CLATRONIC 0261	FORTRESS 1081	0981, 1401, 1611,
ARC EN CIEL 0571		CXC 1171	FRONTECH 0451, 1181, 1981	1621, 2201, 2251,
ARCAM 0571, 0761		DAEWOO 0101, 1501, 1511,	FUJITSU 1261	2271
ARISTONA 0751		2611	FUNAI 0391, 0691, 1171,	INGERSOL 1511
ARTHUR MARTIN 0451, 1641		DANSAI 0101	1181, 1261	INNO HIT 0581, 0601, 0841,
ASA 0411, 0451, 0521,		DECCA 0271, 0581, 0601,	FUTURETECH 1171	1101, 1331, 1371,
0781, 0871, 1021,		0971, 1101, 1691	GBC 0021, 0141, 1321,	1511, 2011
1081, 1421, 2051,		DECCA (UK) 0271, 0581, 0601,	1511, 1621, 1981	INNOVATION 2591, 2601, 2611,
2091, 2151, 2551		1101, 1681	GEC 0451, 1101, 1281,	2621, 2641, 2651,
ASTRA 1511		DEGRAAF 0451, 1351	2321	2661, 2711, 2721,
ATANTIC 0761		DIXI 0991, 1511	GEC (UK) 0031, 0081, 0581,	2761, 2771, 2781
ATLANTIC 0761		DOMEOS 0101	0601, 1101, 1281,	INTERFUNK 0031, 0041, 0061,
ATORI 1511		DORIC 1031	1561	0121, 0181, 0451,
AUDIOSONIC 1181, 1321, 1511		DUAL 0091, 0601, 1611,	GELOSO 0021, 0411, 0451,	0491, 1081, 1641,
AUSIND 0491, 1411		1641, 2101	1321, 1511, 1621,	1791, 1821, 1981,
AUTOVOX 0091, 0351, 0481,		DUAL-TEC 0601, 1511, 1621,	1981	2231
0491, 0601, 0781,		2111	GENERAL TECHNIC 2681	IRRADIO 0491, 1321, 1331,
0951, 1051, 1081,		DUMONT 0261, 0521, 0781,	GENEXXA 0451, 1331	1371, 1411, 1511,
1391, 1421		1021, 1081, 1981,	GOLDSTAR 0591, 0601, 0761,	2011
BAIRD 1101, 1351		2121, 2151	0791, 1371, 1491,	ISUKAI 1331
BANG & OLUFSEN 1081		DYNATRON 0101	1511, 1561, 1621,	ITT 0031, 0041, 0051,
BASIC LINE 1321, 1331		ELBE 1551, 1971, 2031	1641	0061, 0071, 0081,
BAUER 1451		ELECTRO TECH 1511	GOODMANS 0141, 1101, 1371,	0181, 0411, 0451,
BAUR 0041, 0061, 0121,		ELEKTRONSKA 0771	1641, 2301	0491, 1241, 1291,
0131, 0221, 1561		ELMAN 0261, 1621	GORENJE 0981, 1061	1351, 1501, 1601,
BEKO 2491, 2501		ELTA 1511	GRAETZ 0451	1641, 1741, 1921,
BLAUPUNKT 0221, 0231, 0241,		EMERSON 0921, 1021, 1081,	GRANADA 0141, 0451, 0491,	1981, 2091, 2331,
0251, 0471, 0741,		1121, 1171, 1261,	0581, 0601, 1101,	2431
2201, 2211, 2221,		1301	1111, 1351, 1981,	ITT-NOKIA 0031, 0041, 0051,
2231, 2241, 2261,		ERRES 0101	2321	0061, 0071, 0081,
2571, 2581		ETRON 1981	GRANADA (UK) 0081, 0141,	0181, 0411, 0451,
BRANDT 0571, 0651, 0731,		EUROPHON 0261, 0581, 0601,	0451, 0491,	0491, 1241, 1291,
0901, 1821		0771, 1091, 1621,	0581, 0601,	1351, 1501, 1601,
BRIONVEGA 1021, 1051, 1081		2001	1031, 1311,	1641, 1741, 1921,
BRITANNIA 0761		FENNER 0101, 1511	1521, 1561,	1981, 2091, 2331,
BRUNS 0821, 0991, 1021,		FERGUSON 0281, 0371, 0551,	1641	2431
1081		0651, 0781, 0861,	GRUNDIG 0221, 0231, 0471,	JVC (VICTOR) 0071, 0721, 1441,
BSR 0391, 0691, 1621,		0881, 1131, 1181,	0491, 0711, 0741,	1581, 1591, 1741,
1901, 1981		1361, 1461, 1971,	1381, 2021, 2041,	1791
BUSH 0451, 1241, 1331,		1991, 2281, 2311,	2141, 2151	KAISUI 0591, 1321, 1331
1641, 1741, 2131,		2341	HANSEATIC 0021, 0121, 0141,	KAMOSONIC 0601
2151		FIDELITY 0451, 0761, 2281	0431, 0591, 1561	KARCHER 0591, 0601, 0841,
BUSH (UK) 0481, 1561, 1611		FIDELITY (UK) 0561, 0591,	HANTAREX 0581	1091, 1321, 1511,
CANDLE 0791		1931, 2281	HEMMERMANN 0061	1561, 2051
CENTURY 1021, 1081		FILMNET 1141	HIFIVOX 0331, 0571	KAWASHO 0761
CGE 0491, 0811, 0981,		FINLANDIA 0451, 2321	HINARI 0071, 0141, 0451,	KENDO 0261
1401, 1531, 1611,		FINLUX 0021, 0261, 0491,	1261, 1351, 1511,	KENNEDY 0021, 0351, 0951,
1621, 1981, 2201,		0521, 0781, 0811,	1641, 1981, 2011	1981
2251, 2271		0871, 1081, 1411,		2701
CITIZEN 0791		1421, 1981, 2051,		KONKA 0431, 1011, 1021,
		2091, 2121, 2151,		1081, 1541
		2551		

KTV	0601, 1171	NECKERMANN	0451, 0601,	PRIMA	0451	SELECO	0071, 0101, 0351,
LENOIR	0601, 1511		0981, 1081,	PROFEX	1981		0411, 0451, 0951,
LEYEO	1181		1561, 1931,	PROTECH	0641, 1181, 1981		1901, 2061, 2101,
LIFETEC	2591, 2601, 2611,		1981, 2211,	QUELLE	0041, 0061, 0121,	SENTRA	2111
	2621, 2641, 2651,		2231, 2241		0221, 0231, 0391,	SHARP	1601
	2661, 2671, 2681,	NEDIATOR	0101		0491, 0521, 0601,	SHARP	0141, 0151, 0191,
	2691, 2711, 2761,	NICAMAGIC	0761		0781, 1371, 1381,		1761, 1781
	2771, 2781	NIKKAJ	1101, 1331, 1641,		1411, 1421, 1641,	SIAREM	0021, 0261, 0581,
LOEWE OPTA	0121, 0131, 0581,		1701, 2011		1681, 2051, 2091,		0641, 1021, 1081,
	0611, 1081	NOBLIKO	0261, 0491, 0591,		2141, 2151, 2201,		1981
LOGIC	1691, 2281		0641, 1381, 1411		2211, 2231, 2241,	SICATEL	1971
LOGIK	0551, 1681, 2281	NOGAMATIC	0571		2251, 2271, 2551,	SIEMENS	0151, 0221, 0231,
LOWEWE	0831	NOKIA	0031, 0041, 0051,		2571, 2581		0451, 0741, 2011,
LUMA	0351, 0451, 1901		0061, 0071, 0081,	REDIOMARELLI	0101, 0451,		2201, 2211, 2221,
LUXMAN	0791		0181, 0411, 0451,		0661, 0771,		2231, 2241, 2261,
LUXMAN STEREO TUNER			0491, 1241, 1291,		1081		2571, 2581
	0791		1351, 1501, 1601,	RADIONETTE	0031, 2051, 2091	SILVER	1181
LUXOR	0001, 0061, 0181,		1641, 1741, 1921,	RADIOLA	2291	SINGER	0021, 0261, 1021,
	0341, 0421, 0451,		1981, 2091, 2331,	RANK	0481, 2151		1081
	0461, 0491, 0601,		2431, 2461, 2791	RBM	2131, 2151	SINUDYNE	0021, 0061, 0101,
	0671, 1351, 1371,	NORDMENDE	0031, 0291, 0331,	RBM (UK)	0481		0261, 0391, 0641,
	1561, 1601, 1911,		0451, 0531, 0541,	REDIFFUSION	0451, 0661, 1641,		0691, 0851, 0941,
	1921, 1981		0571, 1051, 1131,		1981, 2331		1021, 1081, 1241,
LYCO	1181		1591, 1791, 1811,	REDIFFUSION (UK)	0061, 0081,		1301, 1321, 1481,
MAGNADYNE	0021, 0061, 0261,		1821, 1891, 1941,		1031		1631, 1981
	0581, 0641, 0771,		2631	REX	0071, 0101, 0351,	SKANTIC	0451
	1021, 1081, 1621,	OCEANIC	0321, 1651, 1981		0411, 0451, 0951,	SOLAVOX	0451, 1641, 2011
	1981	OCEANIC (F)	0031, 0061, 0321,		1901, 2061, 2101,	SONOKO	0101, 1181, 1511
MAGNAFON	0261, 0491, 0581,		0441, 1661		2111	SONY	0141, 0171, 1121,
	0591, 0641, 0761,	ONCEAS	0601	RFT	0991, 2511		1681, 1691, 2751
	1091, 2001	ONWA	1171	ROADSTAR	1321, 1511	SOUNDESIGN	1171
MANESTH	0101	ORION	0061, 0391, 0691,	ROTEL	0151	SSS	1171
MARANTZ	0101		0851, 1211, 1241,	SABA	0291, 0331, 0421,	STERN	0071, 0101, 0351,
MARELLI	1081		1251, 1301, 1481,		0451, 0531, 0541,		0411, 0451, 0951,
MARK	0101		1511, 1681, 1691,		0571, 0581, 0651,		1901, 2061, 2101,
MATSUI	0061, 0451, 0601,		1981, 2371, 2421		0731, 0931, 1021,		2111
	0691, 1101, 1151,	OSAKA	2011		1071, 1081, 1131,	SUNKAI	0691
	1241, 1271, 1301,	OSAKI	1101, 1331, 2011		1791, 1811, 1821,	SUPRA	0791
	1511, 1561, 1681,	OSUME	0151		1891, 1941, 2631	TANDBERG	0161, 0331, 0611,
	1691	OTTO VERSAND	0021, 0121,	SACCS	1971		1021, 1421, 1771,
MAXIMAL	0071, 1981		0141, 0221,	SAISHO	0451, 0601, 1161,		1791, 2081
MCMICHAEL	1281		0601, 1561,		1241, 1301, 1511,	TANDY	0191, 0451, 1331,
MEDION	2591, 2601, 2611,		1741, 1981		1671, 1681, 1691		1531
	2621, 2641, 2651,	PAEL	0591, 1411	SALORA	0011, 0041, 0061,	TASHIKO	0141
	2661, 2671, 2681,	PANASONIC	0031, 0201, 0211,		0071, 0341, 0451,	TATUNG	0271, 0581, 0601,
	2691, 2711, 2721,		0451, 0701, 1311,		0671, 1291, 1351,		0971, 1101, 1681,
	2761, 2771, 2781		1751, 1961, 2561,		1521, 1561, 1601,		1691
MEMOREX	1511		2741		1641, 1911, 1921,	TCM	2621, 2641, 2711,
METZ	0231, 0741, 1001,	PANORAMIC	2351		1931, 1981, 2321		2761, 2771, 2781
	1041, 1081, 1481,	PATHE MARCONI	0571	SAMBERS	0261, 0491, 0581,	TECHNICS	1311
	2071, 2081	PATHE' CINEMA (F)	0431, 0591,		0641, 1091, 1371,	TECHWOOD	0791
MGA	1231		1621, 1661,		1411, 2001	TEKNIKA	1171, 1231, 1261
MICROMAXX	2591, 2621, 2641,		1971	SAMSUNG	0101, 0601, 0841,	TELE	1141
	2651, 2711, 2761,	PAUSA	1511		0981, 1101, 1181,	TELEAVIA	0571, 0651, 0731,
	2771, 2781	PAUZA	1511		1371, 1511, 2011		1821
MINERVA	0221, 0231, 0491,	PERDIO	0891, 1101	SANYO	0141, 0151, 0401,	TELEFUNKEN	0291, 0301, 0311,
	1381, 2141, 2151		0021, 0491, 0811,		0601, 0801, 0821,		0551, 0731, 1131,
MISTRAL	2281	PHILCO	0981, 1021, 1081,		0981, 1021, 1101,		1471, 1591, 1791,
MITSUBISHI	0141, 0201, 0231,		1401, 1611, 1621,		1111, 1291, 1351,		1801, 1811, 1821,
	0661, 1191, 1201,		1751, 2201, 2251,		1691, 1741, 2051,		1991, 2161, 2171,
	1231, 1671, 1691,		2271, 2451, 2471		2091, 2551		2181, 2191, 2201,
	1741	PHILIPS	0101, 0361, 0591,	SBR	0681, 0751, 1281,		2251, 2271, 2521,
MIVAR	0491, 0501, 0581,		0621, 0681, 0751,		2281		2631
	0591, 0761, 0771,		0761, 1021, 1081,	SCHAUB LORENZ	0451	TELETECH	1511
	1371, 1431, 2031		1281, 2031, 2281,	SCHNEIDER	0021, 0071, 0091,	TEMPEST	2381, 2391, 2401,
MTC	0791		2291, 2431, 2441,		0451, 0511, 0591,		2411
MULTITECH	0261, 0581, 0601,		2511, 2731		0601, 0751, 1321,	TENSAI	1331, 2091
	0641, 0981, 1321,	PHOENIX	1081		1361, 1621, 1641,	TEXET	0601
	1511	PHONOLA	0751, 1081		2101, 2111, 2291	THOMSON	0331, 0481, 0531,
MURPHY	0451, 2091	PIONEER	0291, 0451, 1341,	SCOTT	1171, 1261		0571, 0631, 0651,
MURPHY (UK)	0081, 1031		1821	SEG	0261, 0601, 0821,		0731, 0901, 1241,
N.E.I.	0101, 0961				0991		1571, 1591, 1791,
NAD	1341	PRANDONI-PRINCE	0411, 0451,	SEI	0641, 0691, 1081,		1811, 1821, 1891,
NEC	0141, 1711, 1721,		0491, 0581,		1301, 1481, 1981		1941, 2531
	1731	PRANDONI-PROMCE	1411			THORN	0741, 0861, 2091,
			0451, 0491, 0581				2251, 2271, 2281

THORN-FERGUSON 0281, 0371,
0551, 0651,
0781, 0861,
0881, 1131,
1181, 1361,
1461, 1971,
1991, 2281
TMK 0141, 0791, 1471
TOSHIBA 0141, 0381, 0481,
1221, 1271, 1701,
1741, 1851, 2151,
2801, 2811
TRANS CONTINENS
0451
TRISTAR 2281
TRIUMPH 0481, 0581, 2121
UHER 0431, 0451, 0481,
0491, 0511, 1311,
1541
ULTRAVOX 0021, 0261, 0591,
1021, 1081, 1981
UNIVERSUM 1181, 2051
UNIVOX 1971
VEGAVOX 0811
VEXA 0101, 1511
VIDEOTON 2481
VORTEC 0101, 0651
VOXSON 0411, 0451, 0491,
1021, 1081
WALTHAM 0451
WATSON 0431, 2201, 2241
WATT RADIO 0021, 0061, 0261,
0591, 0641, 0761,
1091, 1971, 1981,
2001
WEGA 0141, 1081, 1981
WEGA COLOR 1021
WELTBlick 0101
WESTON 1621
WHITE WESTINGHOUSE
0101, 0261, 0431,
0591, 0761, 1401,
1541
YOKO 0601, 1511
ZANUSSI 0071, 0101, 0351,
0411, 0451, 0951,
1901, 2061, 2101,
2111
ZOPPAS 0451

CABLE TV

CABLETIME 1446, 1456, 1476
CLYDE CABLEVISION
1426
FILMNET 1396, 1436
FRANCE TELECOM 1386
GEC 1426
JERROLD 1416
MOVIE TIME 1466
NSC 1466
PHILIPS 1386
PIONEER 0006
SAMSUNG 1496
SCIENTIFIC ATLANTA
1486, 1506
STARCOM 1416
STS 1466
TANDBERG 1366
TELE 1436
TELE +1 1436
TELESERVICE 1406, 1476
TUDI 1376
UNITED CABLE 1416
ZENITH 1406

SATELLITE TUNER

AKAI 1276
ALBA 0826, 1276
AMSTRAD 0166, 0796, 1016,
1026, 1296
ANKARO 0476
AST 0406
ASTRA 0126
BARCOM 0476
BLAUPUNKT 0966
BMC SATELLITE 0106
BRITISH TELECOM 1276
BUSH 0826
BUSH (UK) 0956
CAMBRIDGE 0196, 1276
CANAL PLUS (FRANCE)
1536
CHAPARRAL 0016, 0696, 1006
COLUMBUS 0616
CONNEXIONS 0306, 0426
DISCUS ELIPSE 0856, 0866
DISKXPRESS 0426, 0476
DRAKE 1516
ECHOSTAR 0226, 0236, 0606,
0626, 0666, 0926,
0996, 1046, 1056,
1066, 1106
ELTA 1286
ELTA SAT 0146
EURODEC 1226, 1236, 1246
FERGUSON 0046, 0176, 0186,
0296, 0846, 0956,
1306
FINLUX 0976
FRACARRO 0026, 0536, 0776
FUBA 0476, 0616, 0636,
1056
GIUCAR RECORD 0206, 0336
GRUNDIG 0176, 0946, 0956,
0966
HIGH PERFORMANCE
0916
HIRSCHMANN 0756, 0966
HITACHI 0446, 0516, 0706,
0946
ICX INTERNATIONAL 0886
ITT 0066, 0126, 0176,
0446, 1156
ITT/NOKIA 0066, 0126, 0176,
0446, 1156
JEEMON 0146
JERROLD 0846, 0986
JOHANSSON 0246
JVC 1276
KATHREIN 0116, 0266, 0276,
0366
KOSMOS 0266
KYOSTAR 1036, 1086
LENG 0246
LIFESAT 1326, 1346, 1356
LUXOR 0126, 0136, 0446,
0466, 0506, 1156
0356
MACAB
MASPRO 0016, 0116, 0256,
0956
MEDION 1326, 1346
METZ 0966
MICROMAXX 1326, 1346
MITSUBISHI 0966
MORGANS 0596
MURATTO 0406
NEC 0286, 0316, 0766,
0786, 0836
NETWORK 0046
NIKKO 1136, 1146

NOKIA 0066, 0126, 0176,
0446, 1156, 1166,
1336
NORSAT 0786
OTTO VERSAND 0966
PACE 0046, 0176, 0296,
0936, 0956, 1306,
1566, 1576
PACE MSS 0946
PACE SKY DIGITAL BOX (UK)
1526
PALCOM 0616, 0686, 0706
PALSAT 0396
PALTEC 0706
PANASONIC 0806, 1306
PANSAT 1076
PHILIPS 0326, 0346, 0476,
0956, 1126, 1186,
1196, 1206, 1216,
1306, 1316
PROSAT 1176
PTT TELECOM 0306, 0896
QUELLE 0966
RADIX 1056
REDIFFUSION 0316, 0786
RFT 1186, 1196, 1206,
1216
SAGEM 1256, 1546
SAKURA 0566, 0816
SALORA 0066, 0126, 0136,
0446, 0456, 0486,
0496, 0576
SAMSUNG 0746, 0756
SAT 0406
SATCOM 0896
SATECO 0646
SECTOR 1266
SEDEA 1096
SENTRA 0416
SIEMENS 0896, 0966
SINTRACK 0906
SKYLAB 0476
SKYSCAN 0876
SONY 0736, 0946
STELLA 0306
STRONG 0156, 0396, 1036,
1086
STV 0636
TANDBERG 1116
TANDY 0916
TANTEC 0616
TATUNG 0516, 0546
TECHNISAT 0086, 0096, 0526,
0556, 1056
TELECOM 0306
TELEMAX 0586
THORN-FERGUSON 0046, 0076,
0176, 0186,
0956
TOSHIBA 0946
TPS (FRANCE) 1546
TRIAD 0406
UNIDEN 0036, 0216, 0676,
0716, 0726
US ELECTRONICS 0886
VORTEC 0756, 1036, 1076
VTECH 0436
WINERSAT 0246
WISI 0056, 0356, 0376,
0386, 0406, 0656,
1056, 1156
WOLSEY 0916
XCOM MULTIMEDIA 1556
XSAT (FRANCE) 1556
ZEHNDER 0266, 0406
ZENDER 0406

VCR

AIWA 0042, 0352, 0432
AKAI 0042, 0422, 0492,
0582, 0612, 0642,
0652, 0762, 0912
ALBA 0002, 0112, 0282,
0332, 0342, 0972
AMSTRAD 0322, 0432, 0452
ANITECH 0002
ANITSCH 1002
ASA 0012, 0052
AUDIOSONIC 0002
BAIRD 0042, 0282, 0492
BANG & OLUFSEN 0042
BAUR 0052, 0062, 0812
BLAUPUNKT 0062, 0092, 0252,
0462, 0672, 0992
BRIONVEGA 0032
BUSH 0002, 0282, 0332,
0342, 0512, 0972
BUSH (UK) 0812
CAPEHART 0112
CGE 0042, 0432, 0762
CRAIG 0072, 0482
CROWN 0112, 0282, 0622
DAEWOO 0112, 0282, 0622
DANSAI 0012
DAYTRON 0112
DECCA 0042, 0052, 0432,
0942
DECCA (UK) 0052
DEGRAAF 0052, 0132, 0432,
0532, 0602
DIXI 0442
DUAL 0042, 0632
DUMONT 0052, 0432, 0532
DYNATECH 0432
DYNATRON 0012
ELBE 0122
ELIN 0072
EMERSON 0012, 0162, 0202,
0432, 0512, 0522
0012
ERRES
FERGUSON 0042, 0712, 0722,
0852, 0902, 1012,
1022, 1082
FIDELITY 0432
FINLANDIA 0052, 0532
FINLUX 0012, 0042, 0052,
0082, 0262, 0382,
0432, 0462, 0492,
0532, 0572, 0602,
0912
FIRST LINE 0002, 0912
FISHER 0162, 0482, 0532,
0542, 0572, 0592
FORMENTI-PHOENIX
0012, 0052
FRONTECH 0112
FUNAI 0432
GBC 0002
GEC (UK) 0022, 0052
GELOSO 0002
GENERAL TECHNIC 1172
GOLDSTAR 0012, 0122, 0812,
0952
GOODMANS 0002, 0072, 0282,
0432, 0502
GOODMANS (UK) 0002
GRAETZ 0022, 0042
GRANADA 0052, 0132, 0532,
0572

GRANADA (UK)	0052, 0092, 0462, 0602, 0812, 0822	NOKIA	0022, 0032, 0042, 0072, 0292, 0492, 0532, 0572, 0762, 1152	SINUDYNE	0052, 0382, 0442, 0932
GRUNDIG	0052, 0062, 0092, 0232, 0252, 0262, 0752, 0802	NORDMENDE	0042, 0102, 0142, 0192, 0222, 0242, 0392, 0402, 0632, 0732, 0742, 0762, 0782, 0792, 0832, 0842, 0872	SONOKO	0282
HANSEATIC	0052, 0812	OLYMPUS	0462	SONY	0432, 0552, 0682, 0692, 0942, 0952, 0962, 1122, 1132
HARMAN/KARDON	0122, 0922	OPTONICA	0132, 0502	STS	0602
HCM	0002	ORION	0162, 0202, 0312, 0442, 0512, 0522, 0982	SUNKAI	0512
HINARI	0002, 0202, 0412, 0442, 0522	OSAKA	0432	SUNSTAR	0432
HITACHI	0042, 0172, 0292, 0432, 0602, 0662, 0812, 1022	OSAKI	0002, 0012, 0432	SYLVANIA	0432, 0912
IMPERIAL	0072, 0432	OTTO VERSAND	0052, 0062, 0812	SYMPHONIC	0432, 0912
INGERSOL	0442	PANASONIC	0022, 0212, 0462, 0672, 0992, 1092, 1102, 1182	TANDBERG	0062, 0162, 0522, 0932
INNO HIT	0002, 0052, 0072	PENTAX	0172, 0602	TASHIKO	0132, 0432
INNOVATION	1142, 1162, 1172	PERDIO	0432	TATUNG	0042, 0052, 0432, 0922
INTERFUNK	0022, 0052	PHILCO	1062	TCM	1142, 1162, 1172
IRRADIO	0002, 0012	PHILIPS	0052, 0082, 0092, 0152, 0182, 0362, 0372, 0382, 0472, 0502, 1072	TEAC	0042, 0432
ITT	0022, 0032, 0042, 0072, 0292, 0492, 0532, 0572, 0762	PHONOLA	0052, 0152	TECHNICS	0462
ITT-NOKIA	0022, 0032, 0042, 0072, 0292, 0492, 0532, 0572, 0762	PILOT	0012	TEKNIKA	0012, 0432
JENSEN	0042	PIONEER	0052, 0142, 0372, 0472	TELEFUNKEN	0042, 0192, 0632, 0732, 0742, 0762, 0782, 0882, 0892
JVC (VICTOR)	0042, 0102, 0142, 0272, 0742, 0762, 0782, 0902	PORTLAND	0112	TEMPEST	1032, 1042, 1052
KARCHER	0052, 0072, 0812	PROLINE	0432	TENOSAL	0002
KENDO	0492	PYE	0052, 0152	THOMSON	0042, 0102, 0142, 0192, 0402, 0632, 0762
KENWOOD	0042, 0142, 0572	QUARTZ	0572	THORN	0042, 0902
LIFETEC	1142, 1162, 1172	QUELLE	0012, 0032, 0042, 0052, 0062, 0072, 0092, 0202, 0462, 0522, 0942	THORN-FERGUSON	0042, 0222, 0302, 0712, 0722, 0742, 0762, 0852, 0862, 0872, 0902
LLOYD	0432	RADIONETTE	0022	TMK	0522
LOEWE OPTA	0052, 0092, 0152	REALISTIC	0012, 0072, 0132, 0432, 0482, 0502, 0532, 0572	TONSAI	0002
LOGIK	0002, 0072, 0442	RET	1072	TOSHIBA	0042, 0622, 0912
LUMA	0162	REX	0042, 0742, 0782	TOTEVISION	0012, 0072
LUXOR	0492, 0572, 0812	RICOH	0952	TRIUMPH	0922
M ELECTRONIC	0432	SABA	0042, 0142, 0192, 0222, 0242, 0392, 0632, 0732, 0742, 0762, 0772, 0782, 0792, 0872	UHER	0042, 0072
MAGNADYNE	0052	SAISHO	0162, 0202, 0292, 0442, 0512, 0522, 0972	ULTRAVOX	0032
MAGNASONIC	0572	SALORA	0192, 0572, 0812, 0822, 0912	UNITECH	0072
MANESTH	0012	SAMSUNG	0052, 0072, 0622, 0652, 1192	VECTOR RESEARCH	0122
MARANTZ	0012, 0052, 0092, 0122, 0502	SANSUI	0042, 0142	VIDEO	1162, 1172
MARK	0012	SANYO	0482, 0532, 0562, 0572	WELTBlick	0012
MARTA	0012	SBR	0052, 0152, 0182	WHITE WESTINGHOUSE	0032
MATSUI	0012, 0442, 0512, 0522, 0812, 0972	SCHAUB LORENZ	0022, 0042	XENON	0162
MEDION	1142, 1162, 1172	SCHNEIDER	0002, 0012, 0052, 0072, 0432	YAMAHA	0042, 1202
MEMOREX	0012, 0132, 0432, 0482, 0532, 0572	SEG	0002, 0072	YOKO	0012, 0062, 0072
METZ	0062, 0092, 0932	SEI-SINUDYNE	0442		
MGA	0912	SELECO	0042		
MICROMAXX	1142, 1162, 1172	SENTRA	0112		
MINERVA	0062, 0092, 0252	SHARP	0132, 0502, 0702		
MINOLTA	0172, 0602	SHINTOM	0002		
MITSUBISHI	0052, 0062, 0142, 0912, 0922	SIEMENS	0062, 0092, 0252, 0572		
MTC	0072, 0432				
MULTITECH	0002, 0052, 0062, 0282, 0432				
MURPHY	0432				
N.E.I.	0012, 0052				
NATIONAL	0462				
NEC	0042, 0122, 0142				
NECKERMANN	0032, 0042, 0052, 0072, 0092, 0202, 0522, 0572, 0762, 0812				
NIKKAI	0112				
NOBLIKO	0092				

LD PLAYER

AIWA	0137
FUNAI	0137
HITACHI	0047
MAGNAVOX	0077
PANASONIC	0027
PIONEER	0037
RCA	0067
REALISTIC	0137
SAMSUNG	0017, 0087
SONY	0057, 0097, 0107, 0117
VICTOR	0127
YAMAHA	0007

CD PLAYER

ACCUPHASE	0315
ADC	0865
ADCOM	0785, 1015
AKAI	0115, 0125, 0725, 0735, 0745, 0935, 1155
ARCAM	1875
ARCAM-ROTEL	0165
AUDIO-TECHNICA	0835
AUDIOSONIC	0155
AIWA	1105, 1235, 1245, 1765, 1915, 1935
BSR	0875
CALIFORNIA AUDIO LAB	1075
CARRERA	0555, 0875
CARVER	0825, 1415
CYRUS-ROTEL	0205
DENON	0045, 0955, 1045, 1595, 1795, 1805
DUAL	1005
ELIN	0185
EMERSON	1015, 1285, 1675
FISHER	0105, 0595, 0605, 0825, 1165, 1175
GENEXXA	0525, 0825, 0855, 0875, 0995, 1265, 1285, 1345, 1355, 1485, 1575, 1675, 1715, 1825
GOLDSTAR	0555, 1185, 1195, 1585
GRUNDIG	0175
HARMAN KARDON	0325, 0495, 0565, 1135, 1145, 1155
HITACHI	0065, 0585, 0685, 0945, 1005, 1015, 1225, 1545
INNOVATION	1995, 2005, 2015
ITT-NOKIA	0185
JVC (VICTOR)	0385, 0395, 0455, 0575, 0585
KARCHER	0485
KENWOOD	0025, 0055, 0145, 0215, 0595, 0675, 0695, 0705, 0715, 0925, 1355, 1485, 1575, 1675, 1715, 1825
KORTING	0175
LIFETEC	2015
LIGHT CONTROL	1155, 1645, 1655, 1665
LINN	0165, 1875
LUXMAN	0265, 0275, 0795, 0805, 1295, 1305, 1555, 1925

DVD PLAYER

AKAI	0108
DENON	0368
HITACHI	0388
JVC	0168, 0348
KENWOOD	0288
MAGNAVOX	0248
MITSUBISHI	0268
ONKYO	0128, 0248
PANASONIC	0048
PHILIPS	0188, 0248
PIONEER	0208, 0228
PROSCAN	0308
RCA	0308
SAMSUNG	0148
SHARP	0068
SONY	0028
TECHNICS	0048
THOMSON	0328
TOSHIBA	0088, 0248
YAMAHA	0008, 0048, 0188, 0248
ZENITH	0248

LUXOR 0185, 1895, 1905
 MAGNAVOX 1865, 1875
 MARANTZ 0165, 0175, 0545,
 0665, 1275, 1335,
 1405, 1505, 1875,
 1955
 MATSUSHITA 1095, 1605
 MCS 0535
 MEDION 0075, 1995, 2005,
 2015
 MEMOREX 0525, 1015, 1265,
 1275, 1285, 1675
 MGA 1125
 MICROMAXX 2015
 MISSION 0165, 1875
 MITSUBISHI 1125, 1205
 NAD 0135, 0255, 0285,
 0295, 0305, 0345,
 0755, 0765, 1315,
 1325
 NAKAMICHI 0635, 0645, 1565
 NEC 0405, 0535, 0775,
 0785
 NECKERMAN 0155, 0225
 NIKKO 0835, 1165
 OCEANIC 0185
 OKANO 0155, 0225
 ONKYO 0885, 1385, 1425,
 1455, 1515
 PANASONIC 1055, 1075, 1615,
 1625
 PHILIPS 0165, 0175, 0195,
 1865, 1875
 PIONEER 0095, 0335, 0425,
 0435, 0445, 0525,
 0855, 1035, 1945
 PROTON 0905, 1875
 QUASAR 1075
 RADIOLA 1845, 1855
 RADIOTONE 0485
 REALISTIC 0825, 1015, 1265,
 1275, 1285, 1575
 ROTEL 1875
 SABA 1005
 SAE 1875
 SALORA 0185
 SANSUI 0415, 0965, 0975,
 0985, 1255, 1675,
 1875
 SANYO 0625, 0825, 0845,
 0915
 SCHNEIDER 1845, 1855
 SCOTT 1285, 1675
 SHARP 0025, 0035, 1025,
 1115, 1275, 1635,
 1785, 1815, 1825,
 1835
 SHERWOOD 1275, 1445
 SIEMENS 1085
 SIGNATURE 1155
 SONY 0345, 0355, 0365,
 0375, 0865, 1685,
 1695, 1705, 1715,
 1725, 1735, 1745
 SYLVANIA 1875
 TANDBERG 1885
 TASHIKO 1525
 TCM 1985, 2015
 TEAC 0235, 0245, 1275,
 1365, 1375, 1395,
 1435, 1465, 1475
 TECHNICS 0465, 0475, 1065,
 1075, 1625
 TELEFUNKEN 1005
 THETA DIGITAL 1865

THOMSON 1005
 TOSHIBA 0755, 0765
 VECTOR RESEARCH
 0555, 0865
 YAMAHA 0005, 0015, 0085,
 0345, 0615, 0655,
 0815, 0835, 0895,
 1815

CD RECORDER/CD-RW

HITACHI 0304
 JVC 0334
 MARANTZ 0314, 0324
 PHILIPS 0274
 PIONEER 0284, 0294
 YAMAHA 0244

MD RECORDER

KENWOOD 0214
 SHARP 0264
 PIONEER 0254
 SONY 0224
 YAMAHA 0024, 0224, 0234

TAPE DECK

AKAI 0124
 DENON 0204
 GRUNDIG 0134
 HARMAN 0044
 JVC 0194
 KENWOOD 0164
 KORTING 0134
 LUXMAN 0054, 0064, 0074,
 0084
 MARANTZ 0134, 0144
 NAD 0174
 ONKYO 0184
 PHILIPS 0134, 0144, 0154
 PIONEER 0034, 0114
 SONY 0094, 0104
 YAMAHA 0004, 0014



YAMAHA ELECTRONICS CORPORATION, USA 6660 ORANGETHORPE AVE., BUENA PARK, CALIF. 90620, U.S.A.
YAMAHA CANADA MUSIC LTD. 135 MILNER AVE., SCARBOROUGH, ONTARIO M1S 3R1, CANADA
YAMAHA ELECTRONIK EUROPA G.m.b.H. SIEMENSSTR. 22-34, 25462 RELINGEN BEI HAMBURG, F.R. OF GERMANY
YAMAHA ELECTRONIQUE FRANCE S.A. RUE AMBROISE CROIZAT BP70 CROISSY-BEAUBOURG 77312 MARNE-LA-VALLEE CEDEX02, FRANCE
YAMAHA ELECTRONICS (UK) LTD. YAMAHA HOUSE, 200 RICKMANSWORTH ROAD WATFORD, HERTS WD1 7JS, ENGLAND
YAMAHA SCANDINAVIA A.B. J A WETTERGRENS GATA 1, BOX 30053, 400 43 VÄSTRA FRÖLUNDA, SWEDEN
YAMAHA MUSIC AUSTRALIA PTY, LTD. 17-33 MARKET ST., SOUTH MELBOURNE, 3205 VIC., AUSTRALIA

YAMAHA CORPORATION
Printed in Malaysia ID V722820-1

Connection Guide (when listening to a digital 5.1-channel source)

DVD player

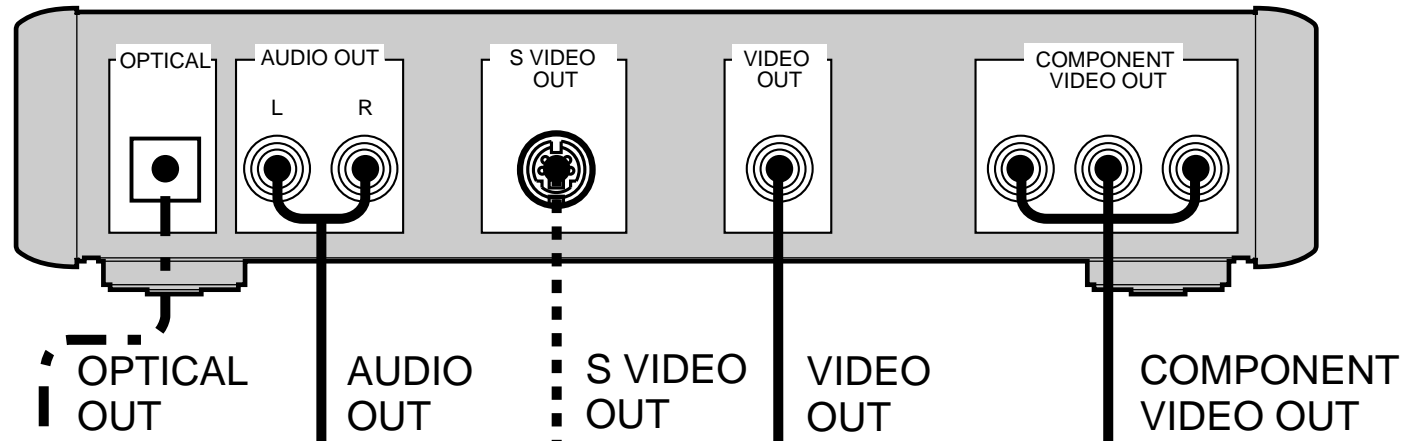

Main speakers A

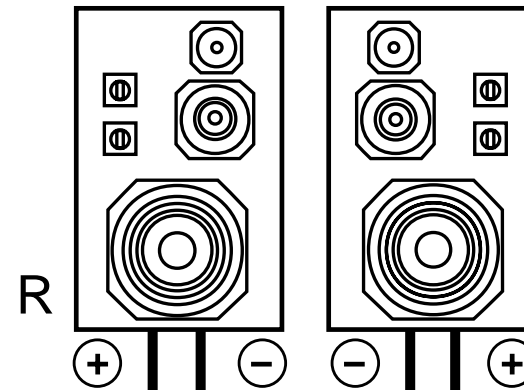

Main speakers B

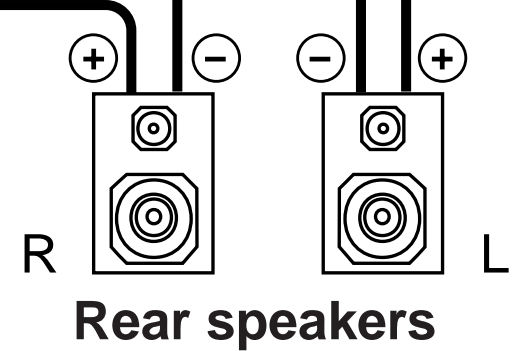
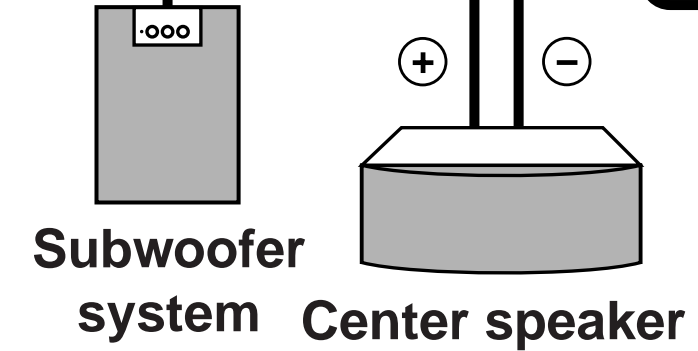
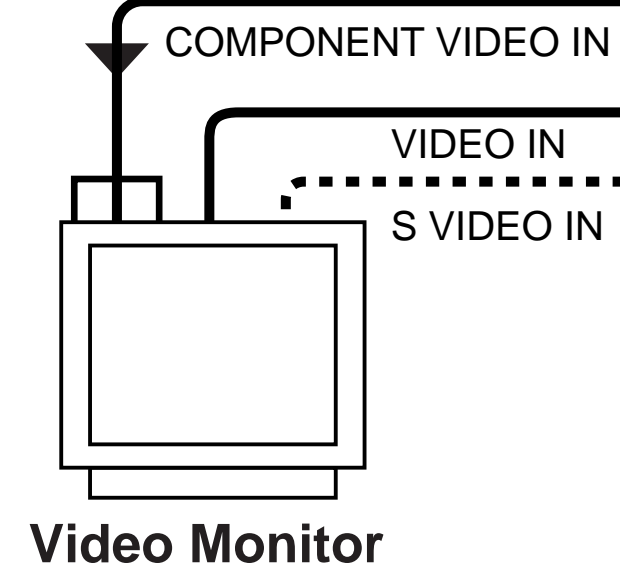
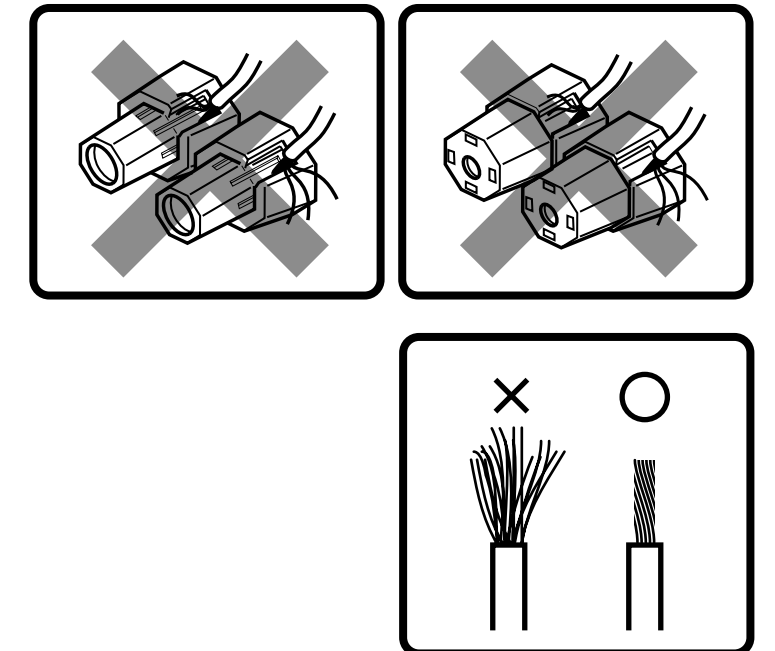
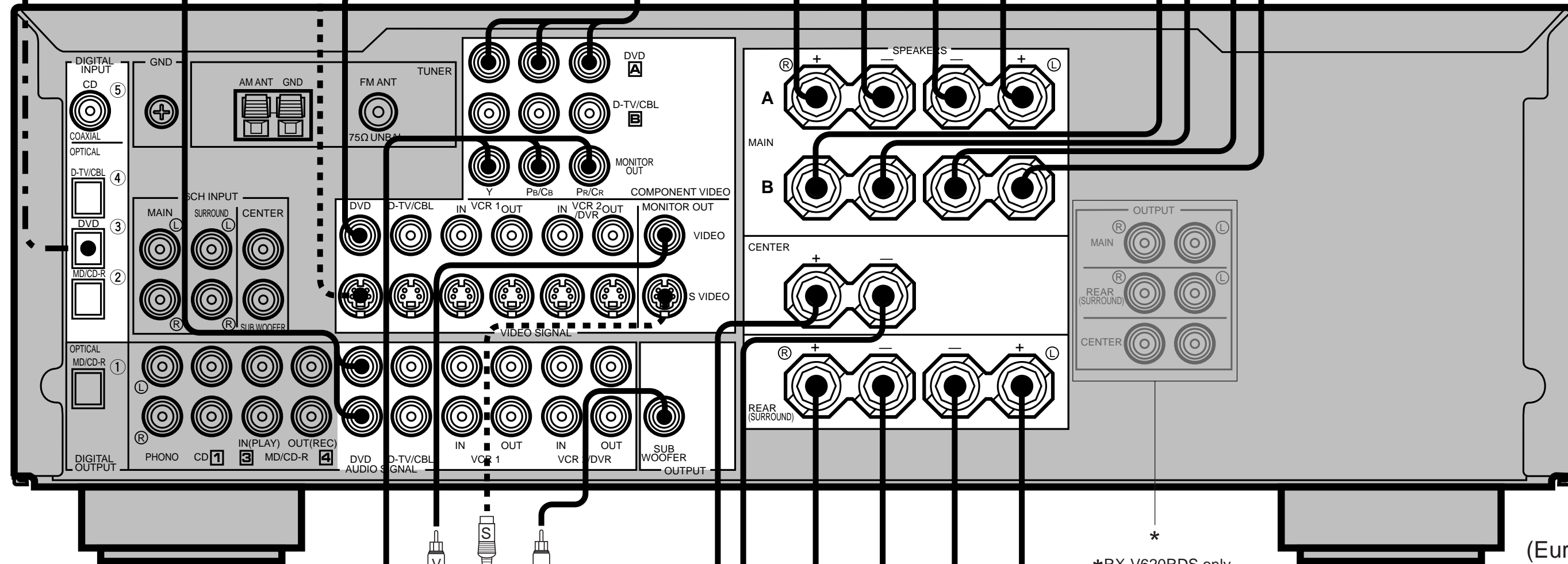
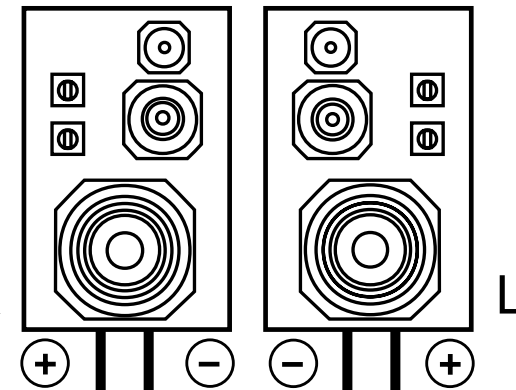

*RX-V620RDS only (Europe model)

- Analog signal
- S Video signal
- Video signal
- Optical signal
- Signal flow

Quick Reference Card

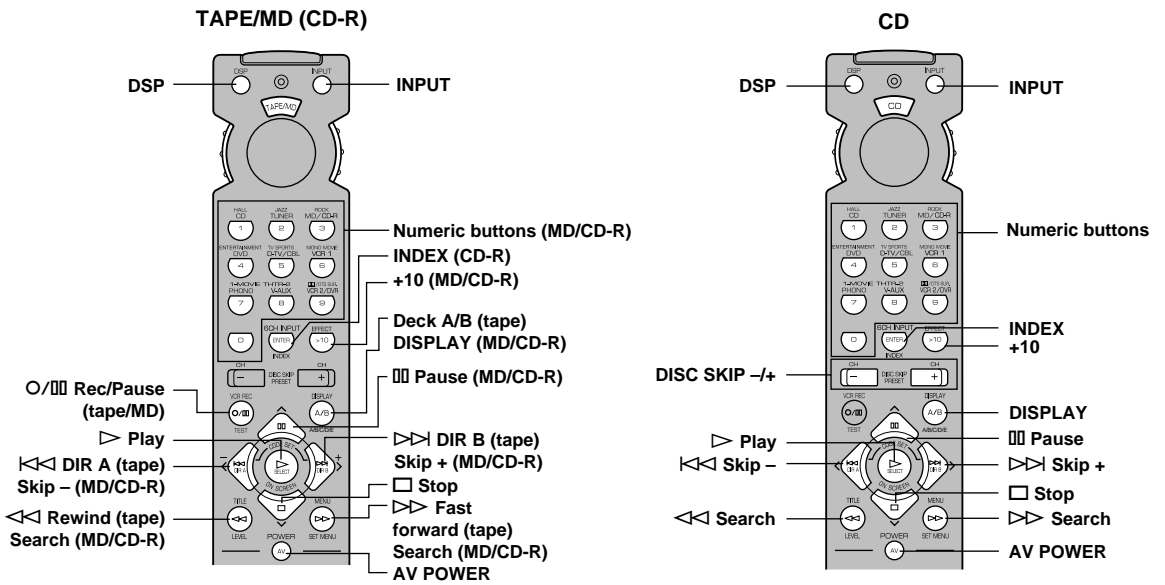
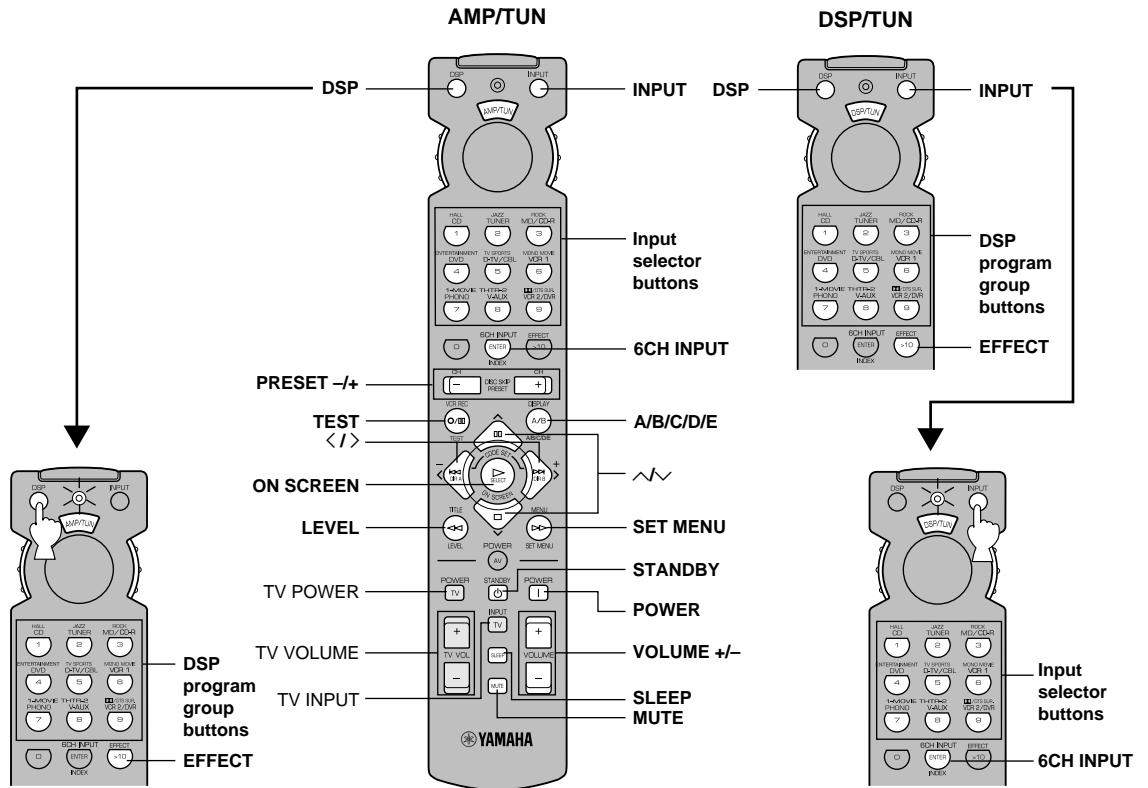

Quick Reference Card

DVD/LD

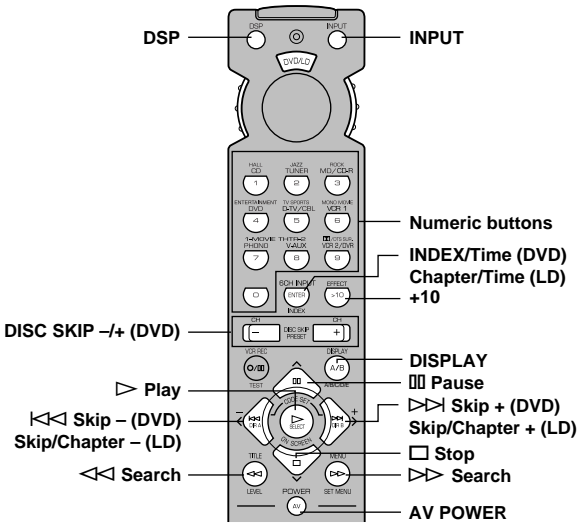

DVD MENU

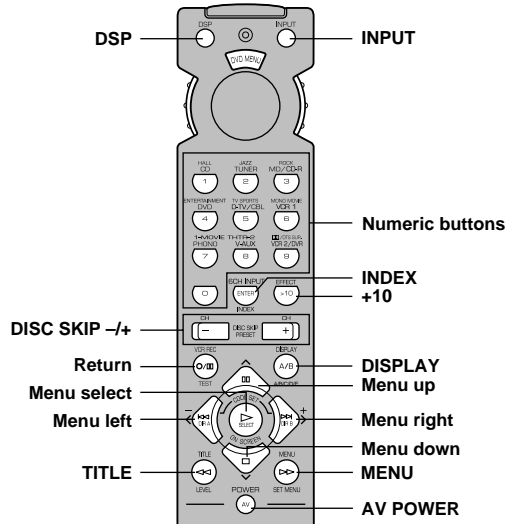

VCR

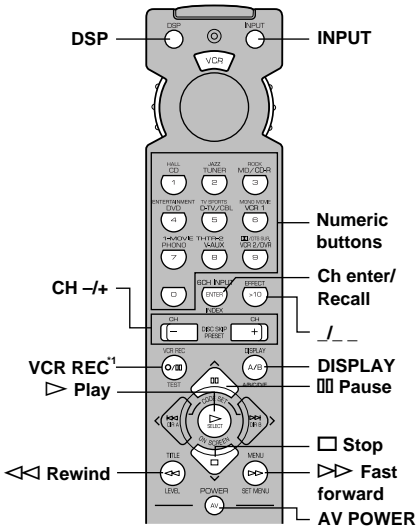

TV

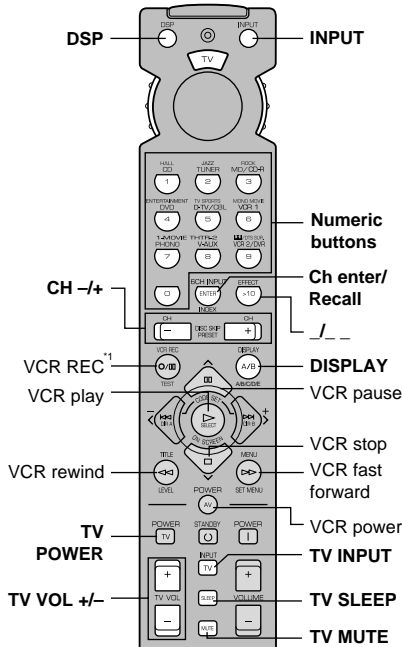

CBL/SAT

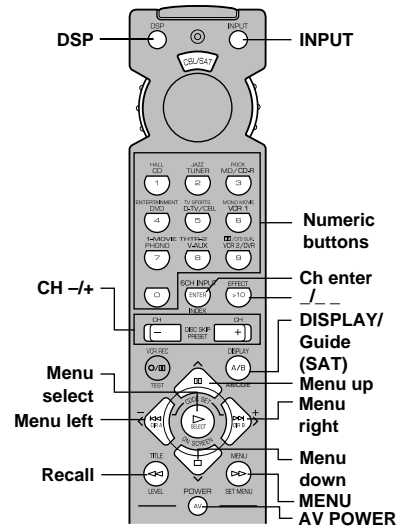

*1 Press this button twice to start recording.
Appuyer deux fois sur cette touche pour commencer l'enregistrement.
Drücken Sie diese Taste zweimal, um die Aufnahme zu starten.
Tryck två gånger på den här knappen för att börja spela in.

Premere due volte questo tasto per iniziare la registrazione.
Presione dos veces este botón para empezar a grabar.
Druk tweemaal op deze toets om met opnemen te beginnen.
按此按钮两次即可开始录像。